



Eye Instruments

Augeninstrumente
Instruments ophtalmiques
Instrumentos oftálmicos
Strumenti oftalmici

20+

Years of
TIG
Performance

About Us:

Welcome to T.I.G International, your global partner in medical instruments!

We are a 20 years old company, manufacturing and supplying high quality, Eye Instruments which are sold under our name in more than 25 countries of the world.

Products

We offer a wide range of different types of Eye instruments, literally covering all aspects of eye surgery.

Policies

We dedicate our success to our fair and honest policies, to our spirit of innovation, to the closest relationship that we establish with our clients and to our firm adherence to total professionalism in all areas of business. Our customers and the members of our team are our best asset and we do our best to safeguard their interest.

Mission

Our mission is to produce the best quality, life saving, eye instruments for the surgeons and thus to contribute in their efforts to save precious lives.

Quality System

To meet the legal requirements, T.I.G International has a full quality assurance system, based on the Medical Devices Directive (93/042 / EEC). We comply with the law by using the latest standards (ISO and EN standards). Our quality system meets the latest requirements of the EN ISO 13485: 2003.

Delivery Time

Please contact T.I.G International regarding actual delivery times of the products.

We hope you enjoy visiting our catalogue and we shall be honored to know your comments about our company, products and services.

Thank you, we are,
Truly yours.

T.I.G International

**NOTE: ALL INSTRUMENTS AVAILABLE IN STAINLESS STEEL MATERIAL,
TITANIUM MATERIAL AND ALSO TITANIUM COLOR COATED.**

Life Time Guarantee.

All T.I.G International precision instruments are guaranteed to be free of manufacturing and workmanship defects.

Any instrument proved to be defective, excluding defects due to misuse or mishandling, shall be repaired or replaced free of cost.

We recommend the use of proper and standard instrument cleaning, handling and preserving techniques to increase the life and functionality of all kinds of Eye instruments.

Description	Page
EYE SPECULA	2-8
SCALPELS AND KNIVES	10,11
KNIVES	13-15
HOOKS	16
RETRACTORS	17
LOOPS	18
SPATULAS	19-21
CHALAZION CURETTES	22,24
FOREIGN BODY INSTRUMENTS	23
LENS MANUPILATORS	25,26
IRIS HOOKS	27
CAPSULE INSTRUMENTS	28
DISSECTING AND TISSUE FORCEPS	30,31
IRIS FORCEPS	32-34
FIXATION FORCEPS	35-39
TYING FORCEPS	40-44
SUTURE FORCEPS	45-49
CORNEAL FORCEPS	50-56
CAPSULE FORCEPS	57
CAPSULOREHEXIS FORCEPS	58
NUCLEUS FORCEPS	59
FRAGMENT FORCEPS	60
CHALAZION FORCEPS	61,62
MUSCLE FORCEPS	63
MICRO NEEDLE HOLDERS	65-69
DELICATE SCISSORS	71-75
MICRO SCISSORS	76-87
LACRIMAL DILATOR	89,90
DCR-INSTRUMENTS	91
CANNULA	92-96

- Eye surgery
- Augen-Instrumentarium
- Oftalmologia
- Chirurgie ophtalmologique
- Oftalmologia

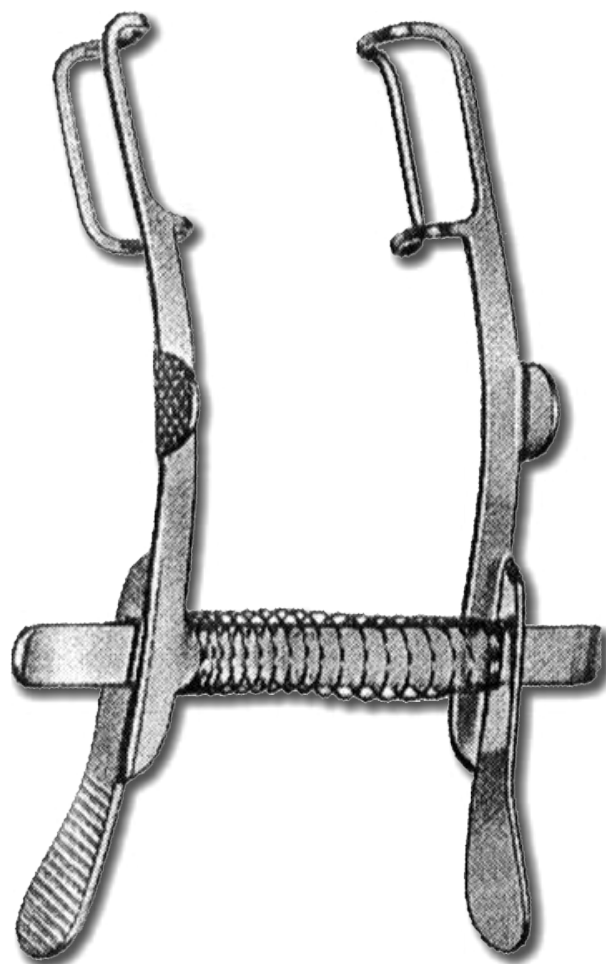

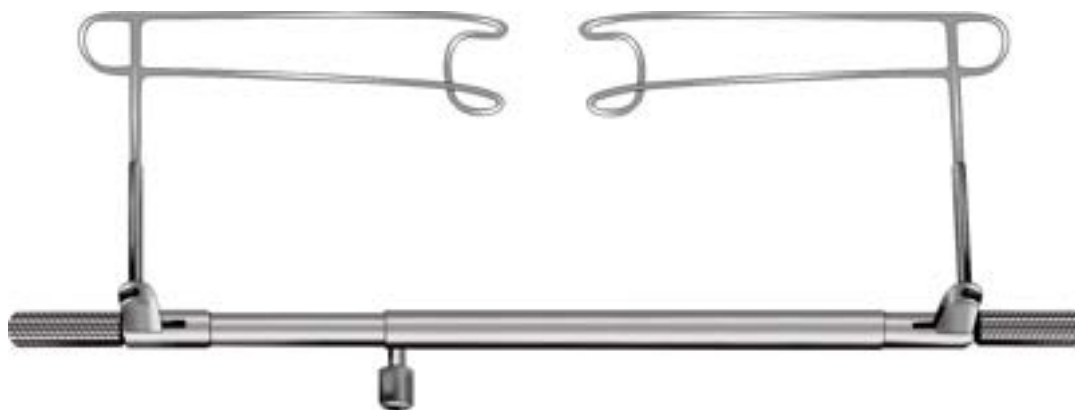

Schott Eye Speculum

Fenestrated, individually adjustable blades for controlled lid elevation

TAB-100.01 Adult Size

TAB-100.02 Child Size



Schott Eye Speculum

With solid, individually adjustable blades for controlled lid elevation

TAB-102.01 Adult Size

TAB-102.02 Child Size

Weiss Eye Speculum
With open blades
PAB-104.06

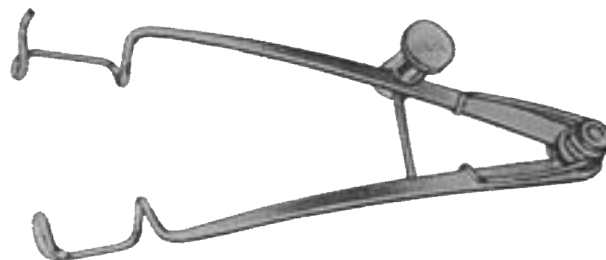

Weiss Eye Specula Large
With fenestrated blades
PAB-105.07

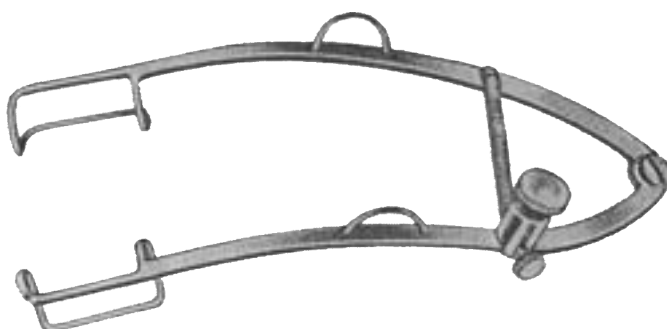

Weiss Eye Specula small
With fenestrated blades
PAB-106.06

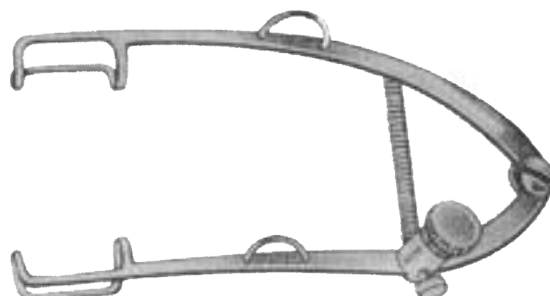

Weiss Eye Specula large
With solid blades
PAB-107.09

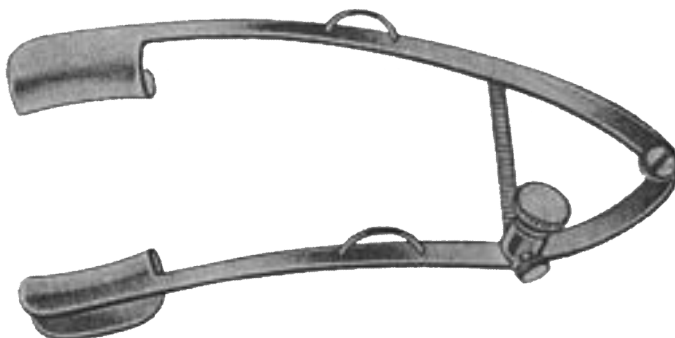

Weiss Eye Specula small
With solid blades
PAB-108.08

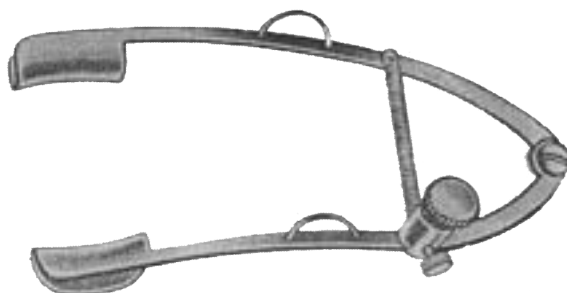

Lester-Burch Eye Specula
With locking screw, solid blades
PAB-109.14

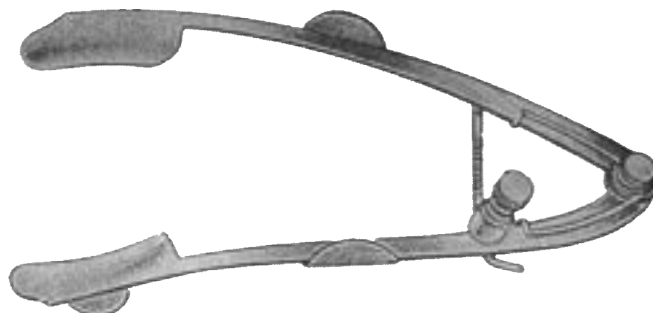

Lancaster Eye Specula
With locking screw, solid blades
PAB-110.06

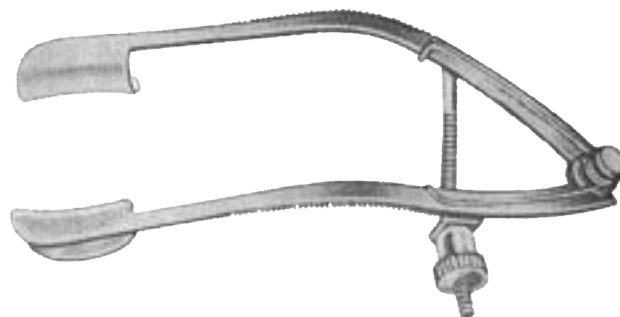

Castroviejo Eye Specula
PAB-111.14 Small (14 mm blades)
PAB-112.16 Medium (16 mm blades)
PAB-113.18 Large (18 mm blades)

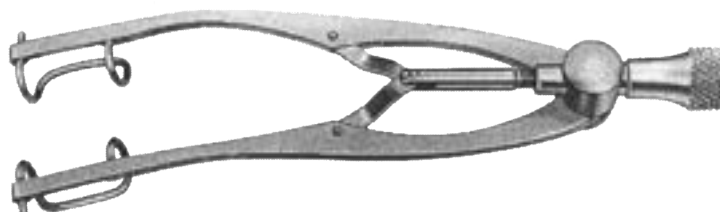

Mellinger-Beard Eye Specula
With solid blades
PAB-114.01 Child size
PAB-114.02 Adult size

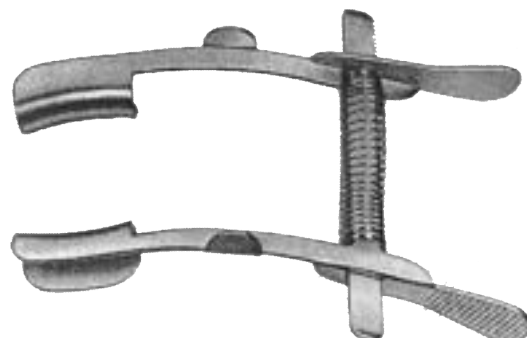

Mellinger Eye Speculum

With fenestrated blades

PAB-115.01 Child size

PAB-116.02 Adult size

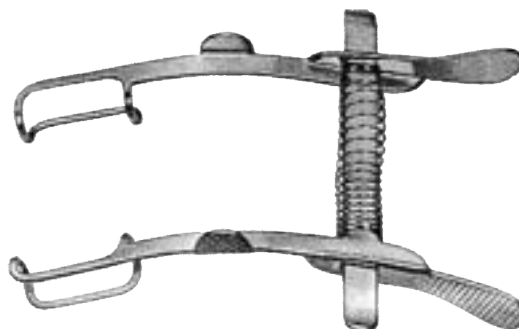

Cook Eye Speculum

Infant size

PAB-117.01

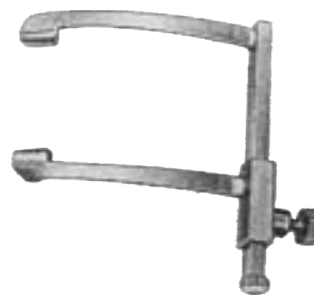

Cook Eye Speculum

Child size

PAB-118.02

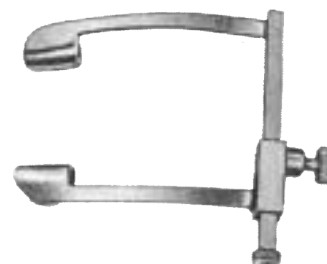

Cook Eye Speculum

Adolescent size

PAB-119.03

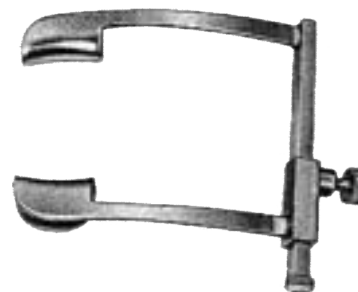

Cook Eye Speculum

Adult size

PAB-120.04

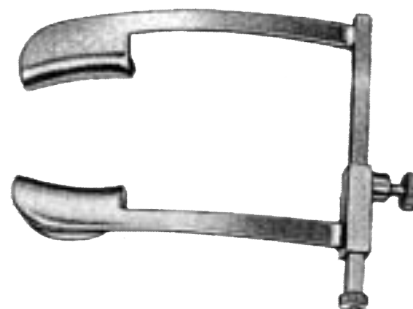

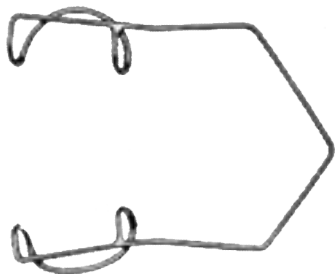

Barraquer Eye Speculum

Fenestrated round blades

PAB-121.14 Adult size (14 mm wide)

PAB-122.10 Child size (10 mm wide)

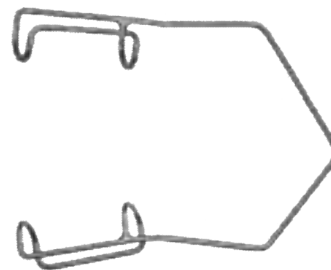
PAB-123.05 Infant size (5 mm wide)

PAB-124.03 premature (3 mm wide)

Barraquer Eye Speculum

Fenestrated blades

PAB-122.15 Adult size (15 mm wide)

PAB-122.10 Child size (10 mm wide)

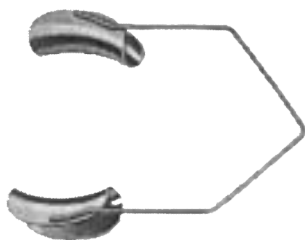
PAB-122.05 Infant size (5 mm wide)

PAB-122.03 Premature (3 mm wide)

Barraquer Eye Speculum

Solid blades

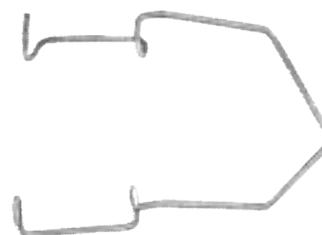
PAB-123.15 Adult size (15 mm wide)

PAB-124.10 Child size (10 mm wide)

Kratz - Barraquer Eye Speculum

Open blades

PAB-125.01 Adult size

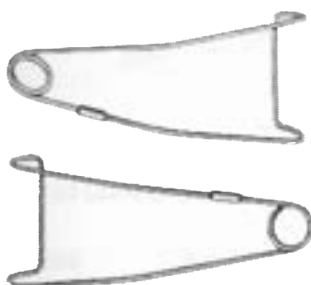
PAB-126.02 Child size

PAB-127.03 Heavy 1 mm model

Jaffe Lid Retractor

With fenestrated blade, may be clamped to surgical drape with suture or elastic band

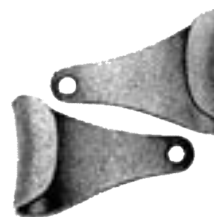
PAB-128.14 Adult size (14 mm wide)

PAB-129.10 Child size (10 mm wide)

Tennant Lid Retractor

With solid blade, may be clamped to surgical drape with suture or elastic band

PAB-130.14 Adult size (14 mm wide)

Clayman Lid Retractor (set of two)

Mobile, fenestrated blade may be clamped to surgical drape with suture or elastic band

PAB-131.14 Adult size (14 mm wide)

Sauer Lid Speculum

Self-retaining, with solid blades

PAB-132.10 Child size (10 mm wide)

PAB-133.06 Infant size (6 mm wide)

PAB-134.04 Premature (4 mm wide)

Murdoch Eye Speculum

With large fenestrated blades

PAB-135.01 Right model

PAB-136.02 Left model

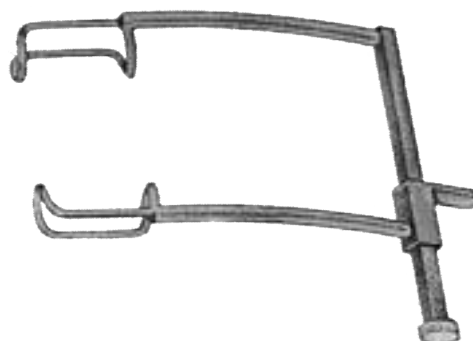

Clark Eye Speculum

With adjustment screw and open blades

PAB-137.08

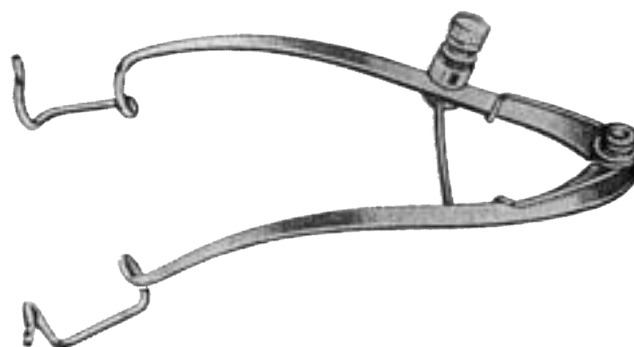

Maumee - Park Eye Speculum

Mobile fenestrated blades with locking screw and hooked enter blade

PAB-138.01

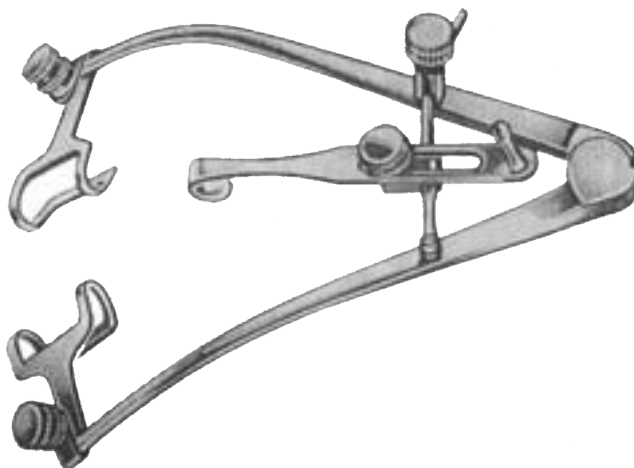

Park - Guyton Eye Speculum

Mobile fenestrated blades with vertical suture posts and hooked center blade

PAB-139.02

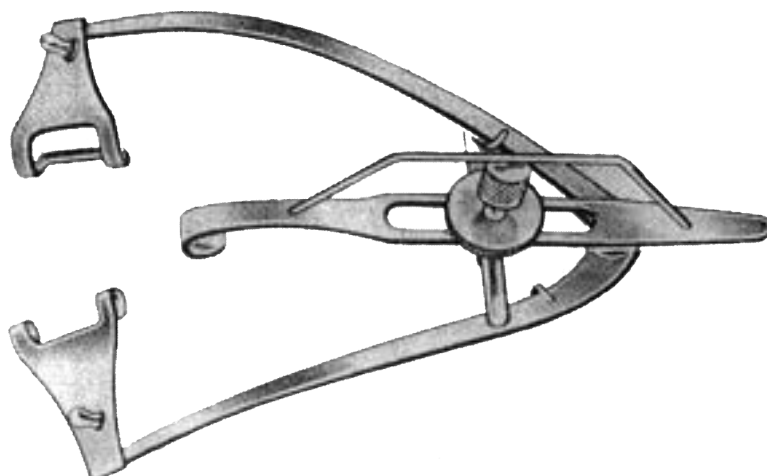

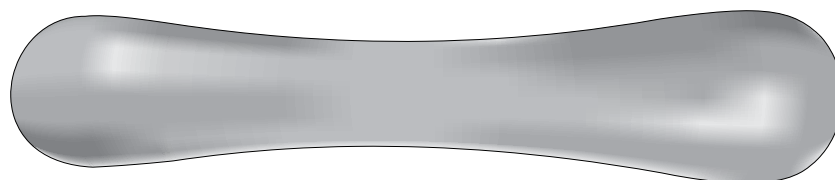

Castroviejo Lid clamp
With locking screw, solid blades
PAB-140.09
Jaeger Lid Plate
Stainless steel
PAB-141.08

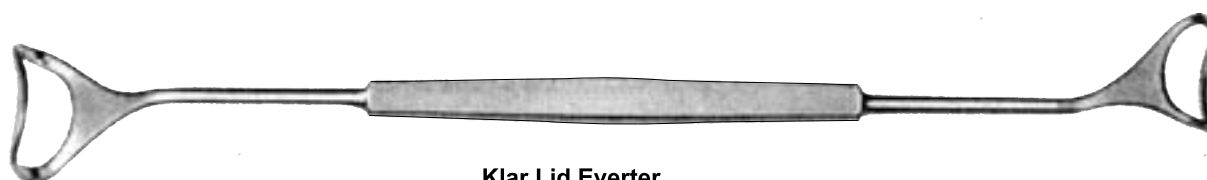

Klar Lid Everter
Open
PAB-142.12

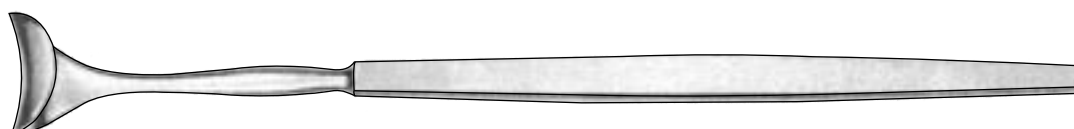

Desmarres Lid Retractor
With solid blade (standard pattern)
PAB-143.08 8 mm wide (Conway)
PAB-144.10 10 mm wide # 0
PAB-145.12 12 mm wide # 1
PAB-146.14 14 mm wide # 2
PAB-147.16 16 mm wide # 3
PAB-148.18 18 mm wide # 4



Desmarres Lid Retractor
With fenestrated blade (new pattern)
PAB-149.12 12 mm wide # 1
PAB-150.14 14 mm wide # 2

• Eye surgery • Augen-Instrumentarium • Oftalmologia
• Chirurgie ophtalmologique • Oftalmologia





PAB-151.03
Scalpel Handle No. 3



PAB-152.07
Scalpel Handle No. 7K



Scalpel Blade Fig. 11
sterile, box of 100 pcs



Scalpel Blade Fig. 15
sterile, box of 100 pcs



Disposable Scalpel No. 11 with Plastic Handle
sterile, package of 10 pieces



Disposable Scalpel No. 15 with Plastic Handle
sterile, package of 10 pieces

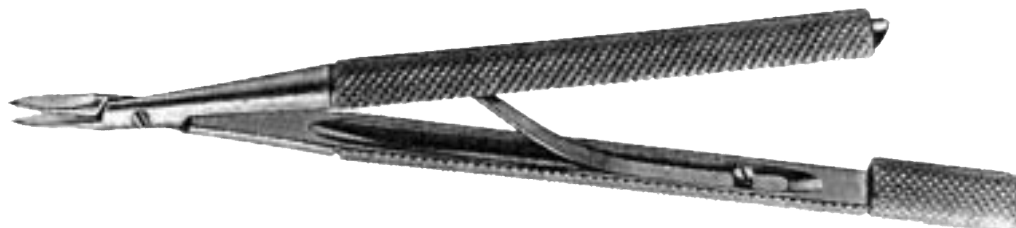

Castroviejo Razor Blade Holder
 Overall length 130 mm with 8 mm handle
PAB-153.00



Castroviejo Razor Blade Holder
 With 6 mm handle
PAB-154.90 Overall length 90 mm
PAB-155.12 Overall length 120 mm

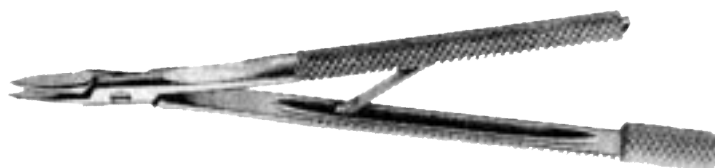
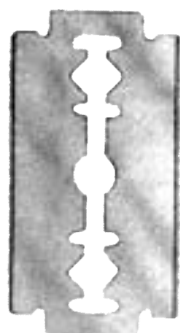

Troutman Razor Blade Holder Straight
 Overall length 95mm
PAB-156.95



Troutman Razor Blade Holder angled
 Overall length 90mm
PAB-157.90



Barraquer Razor Blade Holder
 Overall length 110 mm
PAB-158.11

• Eye surgery • Augen-Instrumentarium • Oftalmologia
• Chirurgie ophtalmologique • Oftalmologia





Knapp Discission Knife
Overall Length 120mm
PAB-159.50 5,0 mm blade
PAB-160.60 6,0 mm blade
PAB-161.70 7,0 mm blade



Ziegler Discission Knife
Overall Length 115mm
PAB-162.20 2,0 mm blade
PAB-163.30 3,0 mm blade
PAB-164.50 5,0 mm blade
PAB-165.60 6,0 mm blade



Wecker Discission Knife
Overall Length 125mm
PAB-166.12 Double adge

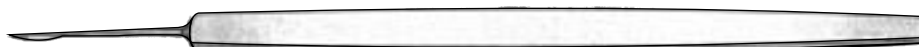

Swiss Pattern Discission Knife
Overall Length 120mm
PAB-167.12



Wheeler Discission Knife
Overall Length 115mm
PAB-168.18 18 mm cutting edge



Barkan Goniotomy Knife
Overall Length 120mm
PAB-169.12



Schele Goniotomy Knife
Overall Length 125mm
PAB-170.12



Graefe Straight Cataract Knife

Overall length 130mm

PAB-171.15 1,5 x 25 mm

PAB-172.20 2,0 x 30 mm

PAB-173.23 2,3 x 33 mm



Graefe Cystotome Knife

Overall length 125mm, malleable shaft with 1,5 mm cutting edge

PAB-174.12



Hamburg Air Keratome

Overall length 125mm, 12 mm, long 45dg angled blade with sharp tip and cutting edges

PAB-175.12



Bonn Scleral Resection Knife

Overall length 125mm

PAB-176.04 4 mm blade

PAB-177.07 7 mm blade



Tooke Corneal Knife

Overall length 115 mm, smooth blade with curved cutting edges

PAB-178.11 3 x 18 mm blade



Paufigue Graft Knife

Overall length 105 mm, angled tip curved cutting edge

PAB-179.10

Cataract Knife

Overall length 135mm

PAB-180.23 Blade 32 x 2,3 mm

PAB-181.26 Blade 35 x 2,6 mm

PAB-182.30 Blade 35 x 3,0 mm

Deuschmann Cataract Knife

Overall Length 135mm

PAB-183.13

Jaeger Keratome Angled

Overall length 135mm

PAB-184.10 10 x 10 mm

PAB-185.11 11 x 11 mm

PAB-186.12 12 x 12 mm

PAB-187.13 13 x 13 mm

Jaeger Keratome Straight

Overall Length 135mm

PAB-188.10 10 x 10 mm

PAB-189.11 11 x 11 mm

PAB-190.12 12 x 12 mm

PAB-191.13 13 x 13 mm

Castroviejo Keratome Angled

Overall Length 135mm

PAB-192.13 4 x 13 mm



Jameson Muscle Hook
Overall length 140 mm
PAB-193.01 Delicate
PAB-194.02 Small
PAB-195.03 Large



Graefe Strabismus Hook
PAB-196.01 # -1 small
PAB-197.02 # 2 medium
PAB-198.03 # 3 large



Stevens Tentotomy Hook
Overall Length 120 mm, blunt 6mm curved tip
PAB-199.12



Gass Retinal Detachment Hook
Overall length 140 mm, flat tip with oval hole
PAB-200.14



Burch Fixation Pick
Overall length 130 mm, with ball stop
PAB-201.13



Twist Fixation Hook
Overall length 120 mm, for scleral fixation
PAB-202.12R Right
PAB-203.12L Left



Tyrell Iris Hook
Overall length 125 mm
PAB-204.12 Sharp
PAB-205.12 Blunt



Knapp Lacrimal Sac Retractor
Overall length 135mm, 4 blunt prongs
PAB-206.13



Rollet Lacrimal Sac Retractor
Overall length 135mm, 4 sharp prongs
PAB-207.13



Arruga Globe Retractor
Overall length 145mm
PAB-208.14



Scherpens Orbital Retractor
Overall length 145mm, smooth forked blade
PAB-209.14



Snellen Lens Loop
Overall length 140mm
PAB-210.14 15 x 4 mm smooth loop



Wilder Lens Loop
Overall length 140mm
PAB-211.14 15 x 4 mm serrated loop



Keener - Arlt Lens Nucleus Loop
Strong curved 3mm wide serrated loop for small incision
nucleus fragment removal
PAB-212.03



Kansas Lens Nucleus Loop
Light curved 3 mm wide serrated loop for small incision
nucleus fragment removal
PAB-213.03



Lewis Lens Loop
PAB-214.01 Small
PAB-215.02 Large



Morrison Lens Loop and Probe
Very thin loop and delicate olive tip
PAB-216.02



Kirby Lens Loop and Expressor Hook
Overall length 145 mm
PAB-217.14



Simcoe Lens Nucleus Loop
Overall length 110 mm, finely serrated on top loop
PAB-218.11

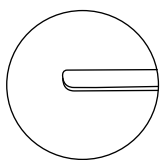

Knolle Lens Nucleus Spatula
Overall Length 120 mm, flat 0,5 mm wide blade
PAB-219.12

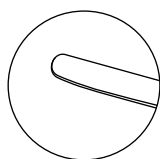

Sinsky Lens Nucleus Spatula
Overall length 120 mm, slightly curved 30 mm long narrow blade
PAB-220.12

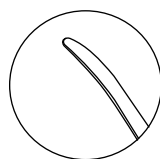

Girard Synchia Spatula
Overall length 115 mm, 0,5 mm wide 10mm vaulted blade
PAB-221.11

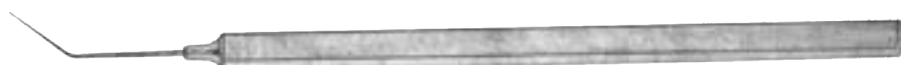
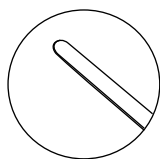

Jaffe Lens Spatula
Overall length 115mm, smooth 0,5mm wide 10 mm angled blade
PAB-222.11

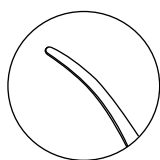

Johnson Sideport Nucleus Spatula
Overall length 115mm, 0,25 mm wide blade, 10 mm vaulted shaft with sharp tip
PAB-223.11

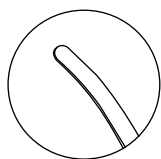

Birnbaum Lens Spatula
Overall length 120 mm, 0,25 mm wide 10 mm vaulted blade
PAB-224.12

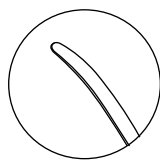

Hirschmann Lens Spatula
Overall length 115 mm, flat 0,5 mm wide 10 mm angled blade
PAB-225.11

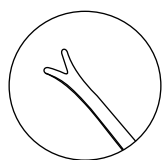

Lippman Sideport Nucleus Spatula
Overall length 115 mm, 0,5 mm wide blade 10 mm vaulted shaft with blunt forked tip
PAB-226.11

Barraquer Iris Spatula

Overall length 120 mm, 0,5 mm round blade with smooth pointed tip

PAB-227.07 7 mm angled

PAB-228.10 10 mm angled

PAB-229.15 15 mm angled

Elschnig Cyclodialysis Spatula

Overall length 135 mm, 1,0 mm wide flat blade

PAB-230.13 12 mm angled

Castroviejo Cyclodialysis Spatula

Overall length 135 mm, with 1,0 mm wide flat blade

PAB-231.10 10 mm angled

PAB-232.15 15 mm angled

Castroviejo Cyclodialysis Spatula

Overall length 135 mm, double - ended 10 and 15 mm long blade with smoothly pointed tips

PAB-233.50 0,50 mm wide blade

PAB-234.75 0,75 mm wide blade

PAB-235.99 1,00 mm wide blade

Paton Spatula and Spoon

Overall length 140mm

PAB-236.14



Wheeler Cyclodialysis Spatula

Overall length 135mm, 1,75 mm wide blades

PAB-237.13 Stainless steel

PAB-238.13 Sterling silver



Wecker Iris Spatula

Overall length 135mm, delicate 0,5 mm wide blade

PAB-239.13



Wecker Iris Spatula

Overall length 135mm, small 1,0 mm wide blade

PAB-240.10 Stainless steel

PAB-241.10 Sterling silver



Wecker Iris Spatula

Overall length 135mm, 2,0 mm wide blade

PAB-242.13 Stainless steel

PAB-243.13 Sterling silver



Kimura Platinum Spatula

Overall length 145mm, with wide ultra thin, flat blade

PAB-244.14



Sautter Orbital Spatula

Overall length 145mm, angled concave curved blade

PAB-245.12 12 mm wide blade

PAB-246.15 15 mm wide blade

PAB-247.18 18 mm wide blade

Meyhöfer Chalazion Curette

Overall length 130 mm, sharp round cup

PAB-248.05 ø 0.50 mm

PAB-249.10 ø 1.00 mm

PAB-250.15 ø 1.50 mm

PAB-251.17 ø 1.75 mm

PAB-252.20 ø 2.00 mm

PAB-253.25 ø 2.50 mm

PAB-254.30 ø 3.00 mm

PAB-255.35 ø 3.50 mm

Hebra Chalazion Curette

Overall length 130 mm, sharp oval cup

PAB-255.10 ø 1.00 mm

PAB-257.20 ø 2.00 mm

PAB-258.25 ø 2.50 mm

PAB-259.30 ø 3.00 mm

PAB-260.35 ø 3.50 mm

Axenfeld Chalazion Curette

Overall length 145 mm double ended

PAB-261.14

Bunge Enucleation Curette

Overall length 145 mm, with round sharp spoon

PAB-262.05 ø 6 mm

PAB-263.08 ø 8 mm

PAB-264.10 ø 10 mm

PAB-265.12 ø 12 mm

Gillis- Welsh Capsule Polishing Curette

Overall length 125 mm, 8 mm backward angled

PAB-266.12 ø 1.5 mm

Daviel Lens Spoon

Overall length 135 mm, light curved, small spoon

PAB-267.13 stainless steel

Daviel Lens Spoon

Overall length 135 mm, light curved, large spoon

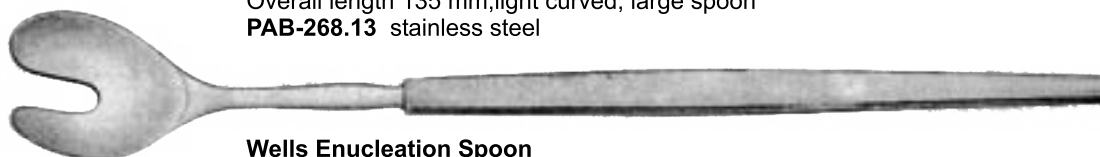
PAB-268.13 stainless steel

Wells Enucleation Spoon

Overall length 145 mm, 21 mm wide blade with notch

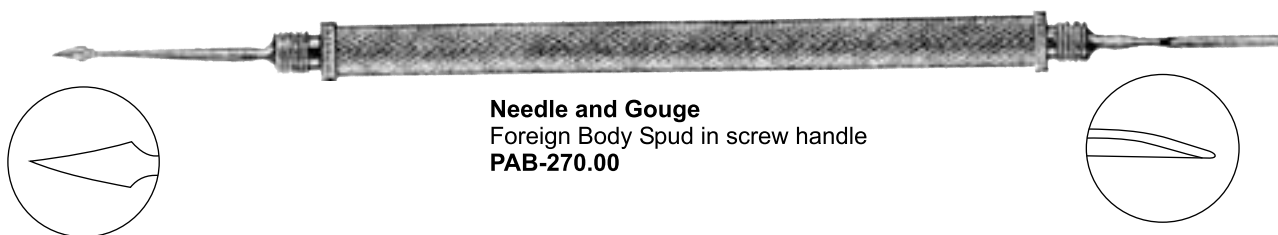
PAB-269.14

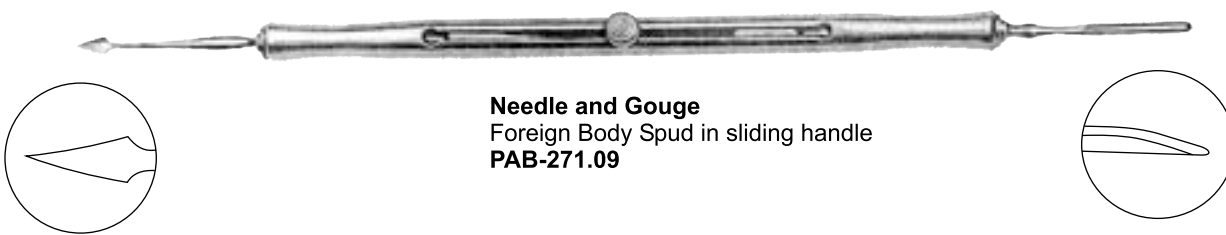

Needle and Gouge
Foreign Body Spud in screw handle
PAB-270.00



Needle and Gouge
Foreign Body Spud in sliding handle
PAB-271.09



Ellis Foreign Body Spud
Overall length 120mm, very thin lightly curved
round tip
PAB-272.12



Francis Foreign Body Spud
Overall length 120mm, flag shaped angled
tip with sharp edge
PAB-273.12



Dezel Foreign Body Needle
Overall length 120mm, sharp spear tip
PAB-274.12 Straight
PAB-275.12 Curved



Golf Club Foreign Body Spud
Overall length 115mm, angled lightly rounded
with sharp edge
PAB-276-11

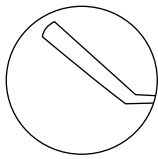

Kansas Nucleus Vectis
Overall length 115 mm, cutting board for
Kansas nucleus bisector and trisector
PAB-280.01 For right handed surgeons
PAB-280.02 For left handed surgeons

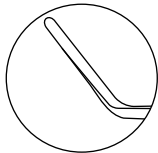

Kansas Nucleus Bisector
Overall length 110 mm, 10 mm angled blade with semi - sharp cutting edge
on the vertical plane, to divide the nucleus in two parts
PAB-281.01

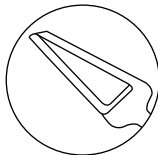

Kansas Nucleus Trisector
Overall length 110 mm
PAB-282.01 For right handed surgeons
PAB-282.02 For left handed surgeons

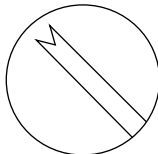

Clayman Nucleus Rotator
Overall length 115 mm, V- Notched 10 mm angled tip
PAB-284.11 Flat 0,5 mm Wide blade

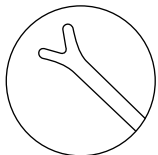

Jaffe-Bechert Lens Nucleus Rotator
Overall length 115 mm, 9 mm angled
PAB-286.11 Blunt forked tip

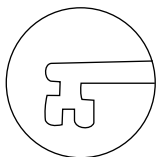

Osher Nucleus Manipulator
Overall length 125 mm, with 0,5 mm two - prong tip
PAB-287.12 Straight
PAB-287.22 Angled

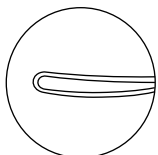

Kansas Nucleus Loop
Overall length 135 mm, light curved 3 mm wide serrated loop
PAB-288.13

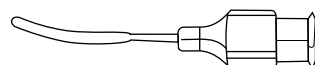
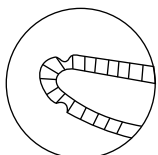

Gruber - Hofmann Irrigating Vectis
25 ga x 3 mm wide serrated loop with two front ports
PAB-290.25

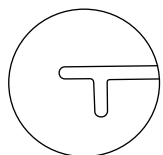

Fenzl Lens Manipulating Hook
Overall length 120 mm 0,15 mm blunt T-Shaped tip,
PAB-292.01 Straight
PAB-292.02 Angled

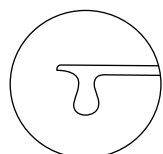

Lester Lens Pusher
Overall length 115 mm straight shaft with Ø 0,25 mm,
hour-glass shaped tip
PAB-293.11

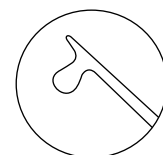

Lester Lens Pusher
Overall length 115 mm angled shaft with Ø 0,25 mm
hour-glass shaped tip
PAB-294.11

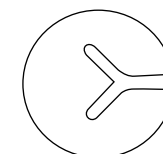

Osher Lens Manipulator
Overall length 115 mm, Y-shaped Hook
PAB-296.11 Straight
PAB-297.11 Angled

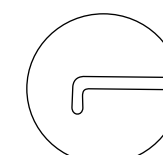

Jaffe IOL Manipulating Hook
Overall length 125mm, blunt tip with 0,15 mm
PAB-298.12 Straight
PAB-299.12 Angled

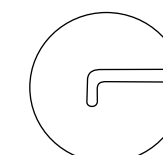

Sinskey II IOL Manipulating Hook
Overall length 125mm, blunt tip 0,2 mm
PAB-300.12 Straight
PAB-301.12 Angled

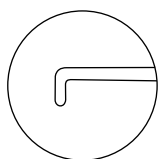

Sinsky II IOL Manipulating Hook
Overall length 115 mm, blunt tip
PAB-302.11 Straight 0,2 mm

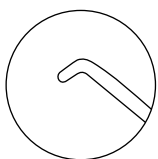

Lewicky IOL Manipulating Hook
Overall length 125 mm, blunt tip
PAB-304.12 0,15 mm

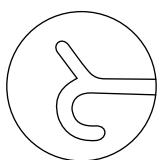

Rentsch Manipulating Hook and Iris Retractor
Overall length 115 mm, blunt boat hook-like tip
PAB-305.11

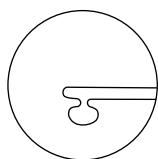

Kuglen Lens Manipulator and Iris Hook
Overall length 120 mm, ball-like tip
PAB-306.12

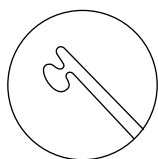

Kuglen Lens Manipulator and Iris Hook
Overall length 120 mm, angled ball-like tip
PAB-307.12

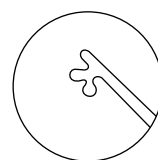

Kuglen Lens Manipulator and Iris Hook
Overall length 120 mm,
PAB-308.12 Straight
PAB-309.12 Angled

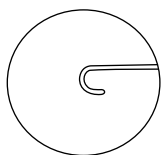

Bonn Micro Iris Hook
Overall length 120 mm very delicate 0,3 mm blunt hook
PAB-310.12 Straight
PAB-310.22 Angled

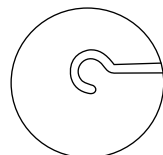

Knolle Iris Hook
Overall length 120 mm, delicate 0,3 mm blunt hook
PAB-311.12 Straight
PAB-312.12 Angled

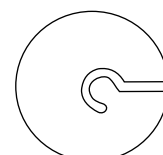

Shepard Iris Hook
Overall length 120 mm small 1,0 mm blunt hook
PAB-313.12 Straight
PAB-313.22 Angled

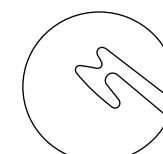

Hirschmann Iris Hook
Overall length 120 mm, blunt 0,75 mm hook
PAB-314.12

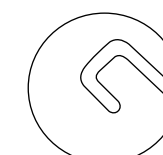

Osher Iris Hook
Overall length 120 mm, blunt 1,5 mm hook
PAB-316.12

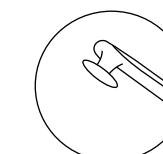

Greather Multi-function Instrument
Overall length 125 mm
PAB-317.12 Straight
PAB-317.22 Angled

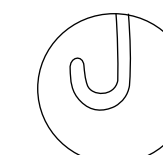

Osher Micro Suture Hook
Overall length 120 mm
PAB-318.12

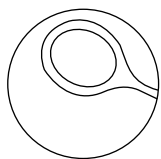

Nordan Capsule Elevator
Overall length 115 mm, angled shaft with delicate ring
PAB-319.11

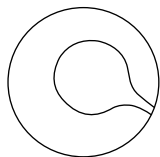

Anis Capsule Scrubber
Overall length 115 mm, with ball shaped tip
PAB-320.11

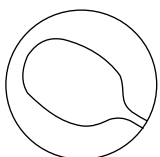

Anis Capsule Scrubber
Overall length 115 mm, with disc shaped tip
PAB-321.11

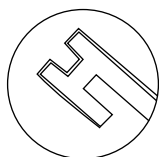

Mackool Capsule Retractor
Overall length 120 mm, 1,0 mm blunt hook with
suspend 0,5 mm from end of tip
PAB-322.12

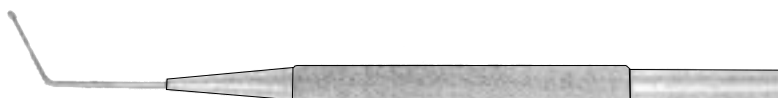
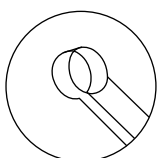

Maro Polishing Ring Curette
Overall length 105 mm, 45 dg angled shaft with
1,5 mm Semi - sharp open ring
PAB-323.10

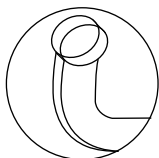

Maro Polishing Ring Curette
Overall length 105 mm, 90 dg angled shaft with
1,5 mm semi-sharp open ring
PAB-324.10

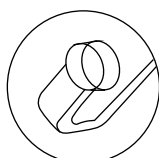

Maro Polishing Ring Curette
Overall length 105 mm, 180 dg backward angled
shaft with 1,5 mm semi-sharp open ring
PAB-326.10

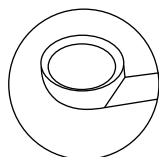

Gills-Volker Capsule Polishing Curette
Overall length 105 mm, gently backward angled
shaft with Ø1,5 mm sharp cup
PAB-327.10

- Eye surgery
- Augen-Instrumentarium
- Oftalmologia
- Chirurgie ophtalmologique
- Oftalmologia

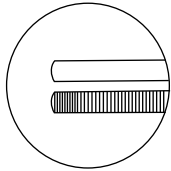

Straight Dressing Forceps with serration

Overall length 100 mm

PAB-330.05 0,5 mm wide tips

PAB-330.07 0,7 mm wide tips

PAB-330.10 1,0 mm wide tips

PAB-330.12 1,2 mm wide tips

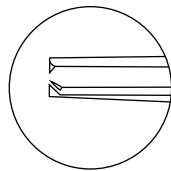
PAB-330.14 1,4 mm wide tips

Straight Tissue Forceps with 1 x 2 teeth

Overall length 100 mm

PAB-332.05 0,5 mm wide tips

PAB-332.07 0,7 mm wide tips

PAB-332.10 1,0 mm wide tips

PAB-332.12 1,2 mm wide tips

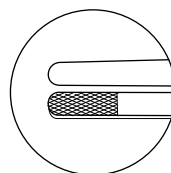
PAB-332.14 1,4 mm wide tips

Bishop Harmon Dressing Forceps

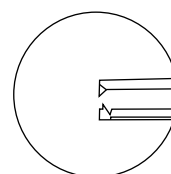
Overall length 85 mm criss-cross serrated

PAB-333.06 0,6 mm wide tips

Bishop Harmon Tissue Forceps

Overall length 85 mm 1 x 2 teeth

PAB-334.06 Delicate 0,6 mm wide tips



Gently curved Dressing Forceps with serration

Overall length 100 mm gently curved tips

PAB-335.07 0,7 mm wide tips



Gently curved Tissue Forceps with 1 x 2 teeth

Overall length 100 mm gently curved tips

PAB-336.07 0,7 mm wide tips



Strong Curved Dressing Forceps with serration

Overall length 100 mm strong curved tips

PAB-337.07 0,7 mm wide tips



Strong curved Tissue Forceps with 1 x 2 teeth

Overall length 100 mm Strong curved tips

PAB-338.07 0,7 mm wide tips

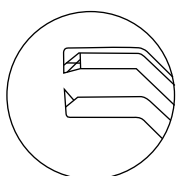

Angled Hess Iris Forceps Swiss pattern

1 x 2 teeth, overall length 100 mm

PAB-339.10

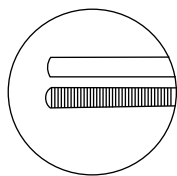

Straight Graefe Iris Forceps
Fine serrated, overall length 65 mm
PAB-340.05 0,5 mm wide shanks
PAB-340.07 0,7 mm wide shanks
PAB-340.10 1,0 mm wide shanks

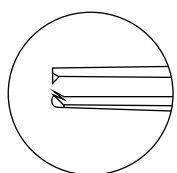

Straight Graefe Tissue Forceps
1 x 2 teeth, overall length 65 mm
PAB-341.05 0,5 mm wide shanks
PAB-341.07 0,7 mm wide shanks
PAB-341.10 1,0 mm wide shanks

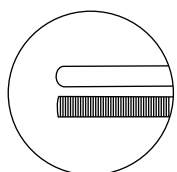

Curved Graefe Iris Forceps
1 x 2 teeth, overall length 65 mm
PAB-342.05 0,5 mm wide shanks
PAB-342.07 0,7 mm wide shanks
PAB-342.10 1,0 mm wide shanks

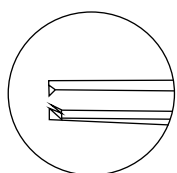

Curved Graefe Tissue Forceps
1 x 2 teeth, overall length 65 mm
PAB-344.05 0,5 mm wide shanks
PAB-344.07 0,7 mm wide shanks
PAB-344.10 1,0 mm wide shanks

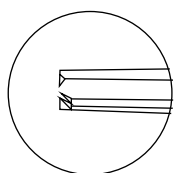

Straight Bonn Micro Iris Forceps
0,12 mm 1x2 teeth, without tying platform
PAB-345.75 Overall length 75 mm
PAB-345.95 Overall length 95 mm

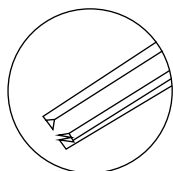

Angled Bonn Micro Iris Forceps

Angled 40 dg 0,12 mm 1 x 2 teeth, without tying platform
Overall length 72 mm
PAB-346.72

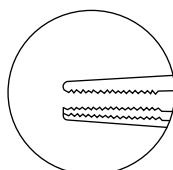

Straight Bonn Micro Iris Forceps

Ultra fine shaft with micro serrations,
Overall length
72 mm
PAB-347.72

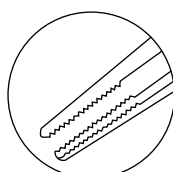

Angled Bonn Micro Iris Forceps

Angled 40 dg ultra fine shaft with micro serrations,
Overall length 72 mm
PAB-348.72

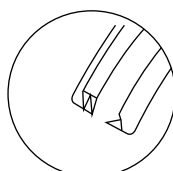

Strong Curved Graefe Tissue Forceps

1 x 2 teeth, overall length 75 mm
PAB-349.75

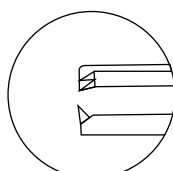

Straight Iris Tissue Forceps

1 x 2 teeth, overall length 75 mm
PAB-350.75

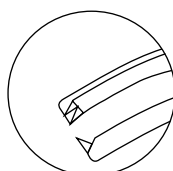

Curved Iris Forceps Swiss pattern

1 x 2 teeth, overall length 100 mm
PAB-351.10

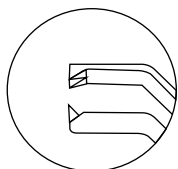

Hess-Engelking Iris Forceps angled
Overall length 72 mm
PAB-352.72 1 x 2 teeth

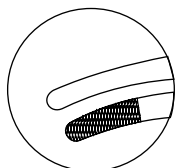

Gill Iris Forceps curved
Overall length 75 mm
PAB-353.10 Cross - serrated
PAB-353.11 1 x 2 teeth

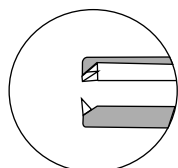

Iris Forceps Zuerich pattern
Overall length 70 mm Extremely delicate
PAB-354.70 1 x 2 teeth

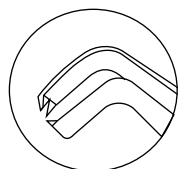

Botvin Iris Forceps double curved
Overall length 70 mm
PAB-355.03 Serrated
PAB-355.04 1 x 2 teeth



Graefe Fixation Forceps without lock

Overall length 110 mm

PAB-356.35 Narrow, 3,5 mm jaws

PAB-356.45 Wide, 4,5 mm jaws



Graefe Fixation Forceps with lock

Overall length 110 mm

PAB-357.45 Wide 4,5 mm teeth



Jess Fixation Forceps

Overall length 110 mm

PAB-358.11



Barraquer Fixation Forceps

Overall length 100 mm

PAB-359.10



Barraquer-Llobera Fixation Forceps

Overall length 95 mm

PAB-360.95

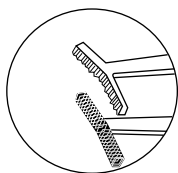

Green Fixation Forceps
 Overall length 100 mm Multiple teeth
PAB-362.05 5,0 mm
PAB-362.10 10,0 mm

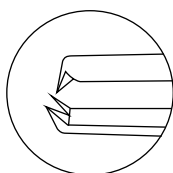

Elschnig Fixation Forceps
 Overall length 105 mm 1 x 2 angular teeth
PAB-363.03 0,3 mm
PAB-363.09 0,9 mm

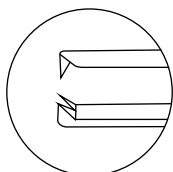

Lester Fixation Forceps straight
 Overall length 95 mm 0,6 mm teeth
PAB-364.12 1 x 2 teeth
PAB-364.23 2 x 3 teeth

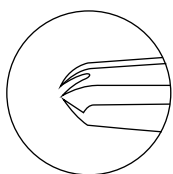

Kuhnt Fixation Forceps
 Overall length 110 mm straight shafts with curved
 1 x 2 teeth
PAB-366.11

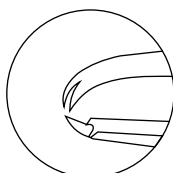

Bracken Scleral Fixation Forceps
 Overall length 105 mm straight shafts with
 delicate 0,7 mm, 1x2 teeth
PAB-368.10

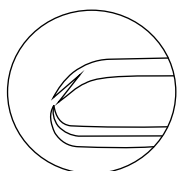

Farkas Bracken Corneal Fixation Forceps

Overall length 105 mm straight shaft with delicate
0,12mm, 1x2 teeth

PAB-370.10

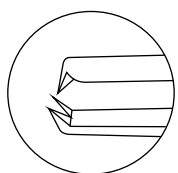

Troutman Superior Rectus Forceps

Overall length 105 mm 45 dg angled shaft, 10 mm
from tip to bend, 1x2 teeth

PAB-372.10

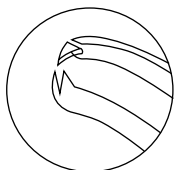

Tennant-Troutman Superior Rectus Forceps

Overall length 105 mm curved shanks 1x2 teeth

PAB-374.10

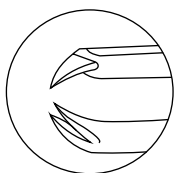

Sauer Suturing Forceps

Overall length 90 mm straight shaft with 1x2
angled teeth

PAB-376.90

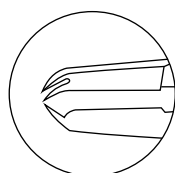

Manhattan Eye & Ear Forceps

Overall length 90 mm straight shaft with 1x2 teeth
6mm long tying platform

PAB-378.90

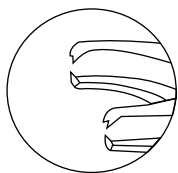

Kremer Corneal Fixation Forceps straight
 Overall length 110 mm, with 2 point fixation, tips separated by 13mm 1x2 teeth each tip 0,12 mm, with catch lock
PAB-380.11

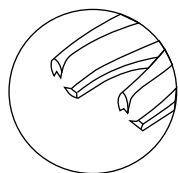

Kremer Corneal Fixation Forceps angled
 Overall length 110 mm, with 2 point fixation, tips separated by 13mm 1x2 teeth each tip 0,12mm, with catch lock
PAB-382.11

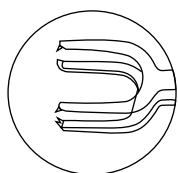

Bores Corneal Fixation Forceps Straight
 Overall length 103 mm, with 2 point fixation, tips separated by 3 mm 1x2 teeth each tip 0,12 mm
PAB-383.10

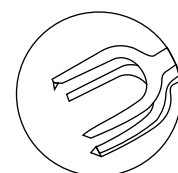

Rubman-Bores Corneal Fixation Forceps Curved.
 Overall length 103 mm, with 2 point fixation, tips separated by 3 mm 1x2 teeth each tip 0,12 mm
PAB-384.10

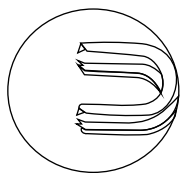
Arrowsmith Corneal Fixation Forceps Straight

Overall length 107mm, with 2 point fixation, tips serrated by 8mm 1x2 teeth each side 0,12 mm with catch
PAB-386.10

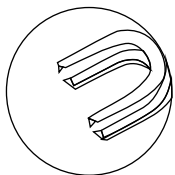
Arrowsmith Corneal Fixation Forceps Curved

Overall length 107mm, with 2 point fixation, tip serrated by 8mm 1x2 teeth each side 0,12 mm with catch
PAB-387.10

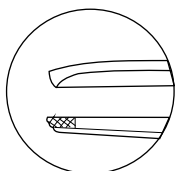
Bonaccolto Conjunctiva Forceps

Overall length 110 mm with 16mm long platform serrated jaws and cross serrated tips
PAB-390.11 1,2 mm wide
PAB-390.12 1,7 mm wide
PAB-390.13 2,4 mm wide

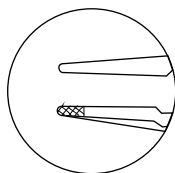
McGregor Conjunctiva Forceps

Overall length 110 mm with 5 mm long tying platform criss-cross serrated tips
PAB-392.11

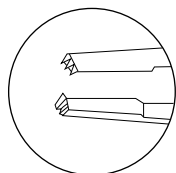
Thorpe Conjunctiva Forceps

Overall length 95 mm with tying platform and 2x3 teeth 0, set at 90 dg
PAB-394.95

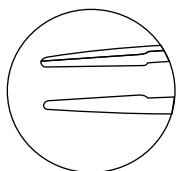

Jaffe Tying Forceps

Overall length 100 mm, every delicate smooth jaws with 6mm long platform for 8-0 to 11-0 sutures

PAB-396.10 Straight

PAB-396.11 Curved

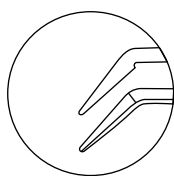

Dardenne Tying Forceps angled

Overall length 100 mm extra delicate 7 mm long angled platform for 9-0 to 11-0 sutures

PAB-398.10

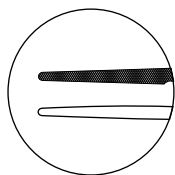

Tennant Tying Forceps with Pin

Overall length 100 mm with guide pin and extra delicate 6 mm long platform for 9-0 to 11-0 sutures

PAB-400.10 Straight

PAB-400.11 Curved

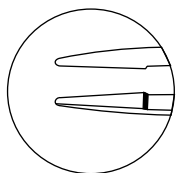

Harms-Tuebingen straight Tying Forceps

Overall length 100 mm with 6 mm long platform for 7-0 to 9-0 sutures

PAB-402.01 Straight

PAB-402.02 Curved

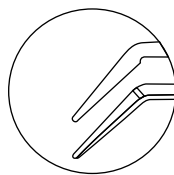

Harms - Tuebingen Tying Forceps angled

Overall length 110mm with 7 mm long delicate angled platform for 7-0 to 9-0 sutures

PAB-403.11

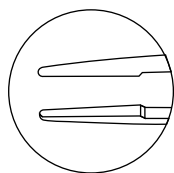

Troutman Tying Forceps

Overall length 100 mm with extra fine 6 mm long platform

for 7-0 to 9-0 sutures

PAB-404.10 Straight

PAB-404.11 Curved

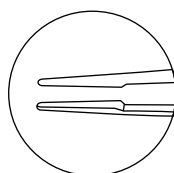

Bonn Tying Forceps (long model)

Overall length 95mm with ultra fine 5 mm long platform

for 9-0 to 11-0 sutures

PAB-405.95

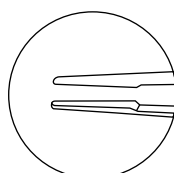

Bonn Tying Forceps (short model)

Overall length 73 mm with ultra fine 5 mm long platform for

9-0 to 11-0 sutures

PAB-406.73

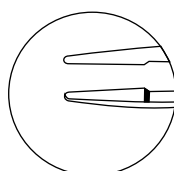

Micro Tying Forceps

Overall length 85 mm with extra fine 6 mm long platform

for 8-0 to 11-0 sutures

PAB-407.85

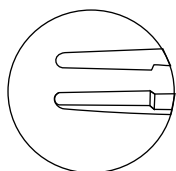

Paufigue Tying Forceps

Overall length 85 mm with standard 7 mm long platform sutures below 7-0

PAB-408.85

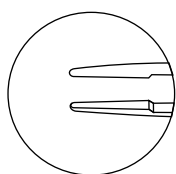

Paufigue Tying Forceps

Overall length 85 mm with delicate 5 mm long platform for 7-0 to 9-0 sutures

PAB-410.85

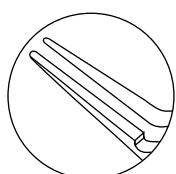

Bechert-McPherson Tying and IOL Forceps

Overall length 105 mm with angled 10 mm long platform for 8-0 to 11-0 sutures

PAB-411.10

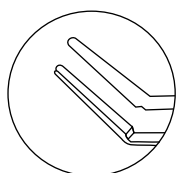

McPherson Tying Forceps angled

Overall length 105 mm with 5 mm long platform for 7-0 to 9-0 sutures

PAB-412.10

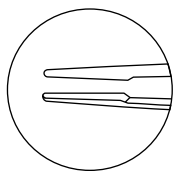

McPherson Tying Forceps Straight

Overall length 105 mm with 5 mm long platform for 8-0 to 11-0 sutures

PAB-413.10

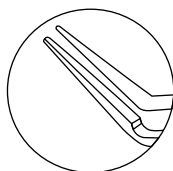

Kelman-McPherson Tying Forceps

Overall length 105 mm with angled 7,5 mm long platform for 8-0 to 11-0 sutures

PAB-414.10

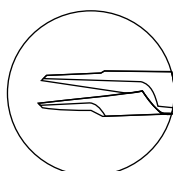

Anis Tying Forceps

Overall length 100 mm with extra delicate 7 mm long platform for 9-0 to 11-0 sutures

PAB-416.10 Straight

PAB-416.11 Curved

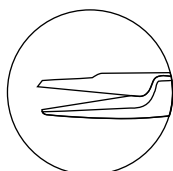

Sinsky Tying Forceps

Overall length 100 mm with very delicate 7 mm long platform for 9-0 to 11-0 sutures

PAB-418.10 Straight

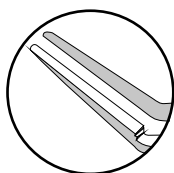

Gaskin Fragment Forceps angled

Overall length 110mm with guide pin and extra fine
11 mm long angled platform
PAB-420.11

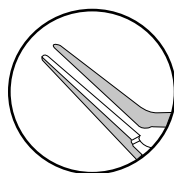

Kelman-McPherson Tying Forceps angled

Overall length 110mm with guide pin and extra fine
8 mm long platform for 9-0 to 11-0 sutures
PAB-421.11

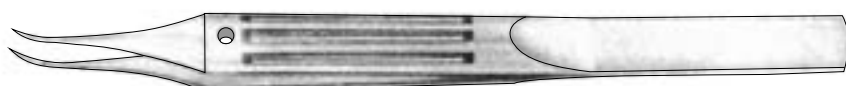
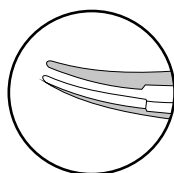

Tennant curved Tying Forceps

Overall length 110mm with guide pin and extra fine
6 mm long platform for 9-0 to 11-0 sutures
PAB-422.11

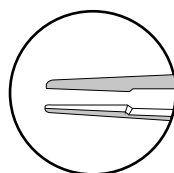

Tennant straight Tying Forceps

Overall length 110mm with guide pin and extra fine
6 mm long platform for 9-0 to 11-0 sutures
PAB-423.10

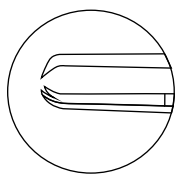

Castroviejo Suturing Forceps

Overall length 105 mm with tying platform and 1x2 teeth

PAB-424.12 0,12 mm

PAB-424.30 0,30 mm

PAB-424.50 0,50 mm

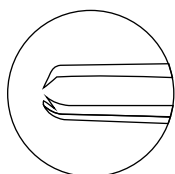

Castroviejo Suturing Forceps (standard handle)

Overall length 100 mm with tying platform and 1x2 teeth

PAB-425.12 0,12 mm

PAB-425.30 0,30 mm

PAB-425.50 0,50 mm

PAB-425.90 0,90 mm

PAB-425.95 1,50 mm

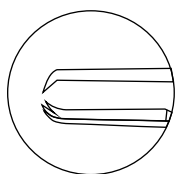

Castroviejo Suturing Forceps (wide handle)

Overall length 100 mm with tying platform and 1x2 teeth

PAB-426.12 0,12 mm

PAB-426.30 0,30 mm

PAB-426.50 0,50 mm

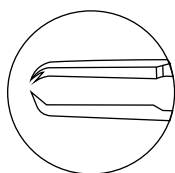

Sinder-Castroviejo Suturing Forceps

Overall length 110 mm with guide pin, tying platform and 1x2 teeth 0,12 mm

PAB-427.11

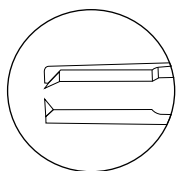

Jaffe Suturing Forceps
Overall length 110 mm 1x2 teeth 0,12 mm set at 90 dg and very delicate platform
PAB-428.11

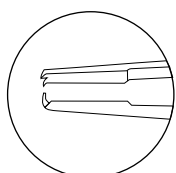

McPherson Suturing Forceps
Overall length 105 mm with 1x2 teeth and straight 5 mm long platform
PAB-429.10

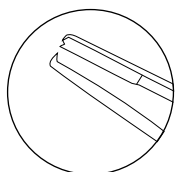

McPherson Suturing Forceps
Overall length 105 mm with 1x2 teeth and straight 5 mm long platform
PAB-430.10

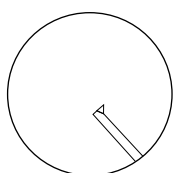

Kelman-McPherson Suturing Forceps
Overall length 105 mm with 8 mm long angled platform and 1x2 teeth 0,12 mm set at 90 dg
PAB-431.10

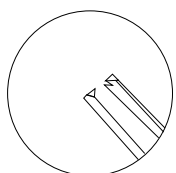

Hoffer-McPherson Suturing Forceps
Overall length 105 mm with 11 mm long angled platform and 1x2 teeth, 0,12 mm set at 90 dg
PAB-432.10

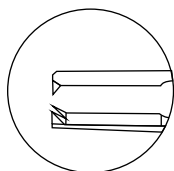

Troutman Suturing Forceps

Overall length 100 mm with extra fine tying platform and 1x2 teeth, 0,12 mm set at 90 dg

PAB-434.10

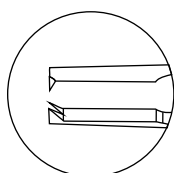

Troutman Suturing Forceps

Overall length 100 mm with extra delicate tying platform and 1x2 teeth 0,12 mm set at 90 dg

PAB-435.10

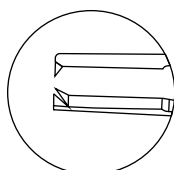

Bonn Suturing Forceps (long model)

Overall length 95 mm with ultra fine tying platform and 1x2 teeth 0,12 mm set at 90 dg

PAB-436.95

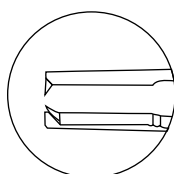

Bonn Suturing Forceps (short model)

Overall length 73 mm with ultra fine tying platform and 1x2 teeth 0,12 mm set at 90 dg

PAB-437.73

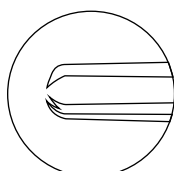

Micro Tying Forceps

Overall length 85 mm with extra fine platform and 1x2 teeth 0,12 mm set at 45 dg

PAB-438.12 12 mm long platform

PAB-438.13 3 mm long platform

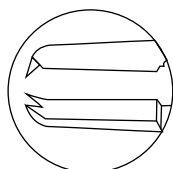

Paufique Universal Suturing Forceps

Overall length 88 mm 1x2 teeth of 0,70 mm set at 45 dg and tying platform

PAB-439.12

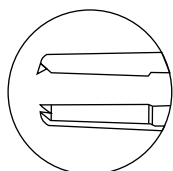

Paufique Universal Suturing Forceps delicate

Overall length 85 mm 1x2 teeth of 0,30 mm set at 45 dg and tying platform

PAB-440.85

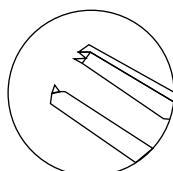

Castroviejo Suturing Forceps (standard handle)

Overall length 105 mm 1x2 teeth and angled tying platform

PAB-441.30 0,30 mm

PAB-441.50 0,50 mm

PAB-441.55 1,50 mm

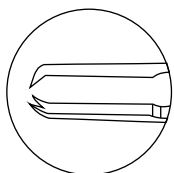

Castroviejo Suturing Forceps

Overall length 110 mm with guide pin, tying platform and 1x2 teeth 0,12 mm set at 45 dg
PAB-442.11

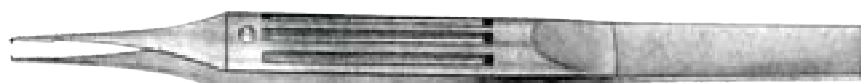
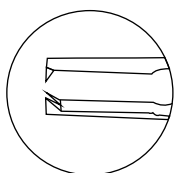

Bonn Suturing Forceps

Overall length 110 mm with guide pin, tying platform and 1x2 teeth 0,12 mm set at 90 dg
PAB-443.11

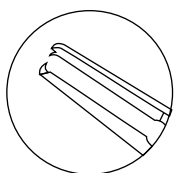

Kelman Suturing Forceps angled

Overall length 110 mm with 8mm long tying platform, guide pin and 1x2 teeth, 0,12 mm set at 90 dg
PAB-445.11

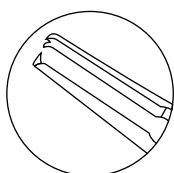

Hoffer Suturing Forceps angled

Overall length 110 mm with 11 mm long tying platform, guide pin and 1x2 teeth, 0,12 mm set at 90 dg
PAB-446.11

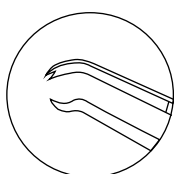

Troutman Suturing Forceps

Overall length 110 mm with guide pin, tying platform and 1x2 teeth 0,12 mm set at 45 dg
PAB-447.11

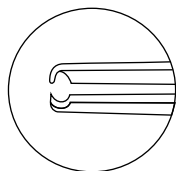

Pierse Corneal Forceps
Overall length 110 mm 1x1 pierse teeth 0,1 mm
PAB-448.01 Straight
PAB-448.02 Curved

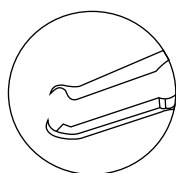

Pierse Corneal Fixation Forceps
Overall length 75 mm 1x1 pierse teeth and
tying platform
PAB-448.10 0,10 mm teeth
PAB-448.20 0,20 mm teeth

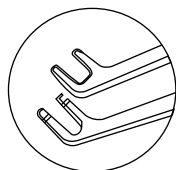

Pierse - Polack Corneal Fixation Forceps
Overall length 75 mm with 1x1 pierse teeth 0,20 mm at
each tip, 1 mm spread
PAB-449.75



Polack Corneal Fixation Forceps
Overall length 75 mm, two 2,75 mm long tips separated 1 mm
with 1x2 teeth 0, 12 mm
PAB-450.75

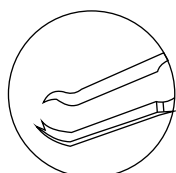

Standard Corneal Suturing Forceps
Overall length 72 mm with 1x2 teeth of 0,45 mm and
tying platform
PAB-451.72

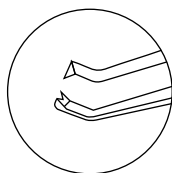

Barraquer Corneal Utility Forceps

Overall length 75 mm 1x2 teeth without tying platform

PAB-452.12 0,12 mm

PAB-452.30 0,30 mm

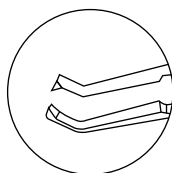

Barraquer Corneal Suturing Forceps

Overall length 75 mm 1x2 teeth with tying platform

PAB-453.12 0,12 mm

PAB-453.30 0,30 mm

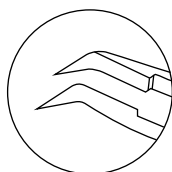

Barraquer Suture Removing Forceps

Overall length 75 mm 1x1 teeth with tying platform

PAB-454.75

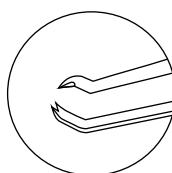

Troutman Corneal Fixation Forceps

Overall length 75 mm 1x2 teeth without tying platform

PAB-455.12 0,12 mm

PAB-455.30 0,30 mm

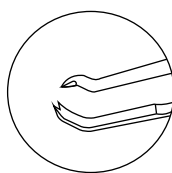

Troutman Corneal Suturing Forceps

Overall length 75 mm 1x2 teeth with tying platform

PAB-456.12 0,12 mm

PAB-456.30 0,30 mm

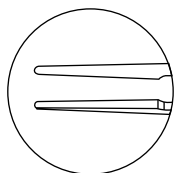

Straight Corneal Tying Forceps

Overall length 85 mm with extra fine 5 mm long jaws and tying platform

PAB-457.85

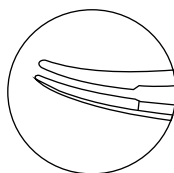

Curved Corneal Tying Forceps

Overall length 82 mm with extra fine 5 mm long jaws and tying platform

PAB-458.82

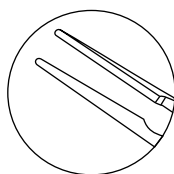

Angled Corneal Tying Forceps

Overall length 82 mm with extra fine 7 mm long angled jaws and tying platform

PAB-459.82

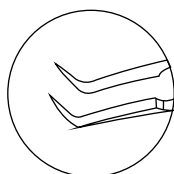

Colibri Corneal Forceps

Overall length 83 mm with extra fine 5 mm long jaws and tying platform

PAB-460.11 Smooth tips, for tying

PAB-460.13 Pointed tips, for suture removal

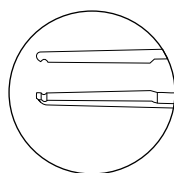

Straight Corneal Fixation Forceps
Overall length 85 mm 1x1 pierse teeth with tying platform
PAB-461.85 0,10 mm teeth

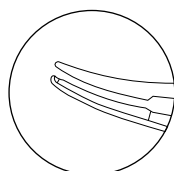

Curved Corneal Fixation Forceps
Overall length 82 mm 1x1 pierse teeth with tying platform
PAB-462.82 0,10 mm teeth



Angled Corneal Fixation Forceps
Overall length 82 mm 1x1 pierse teeth with tying platform
PAB-463.82 0,10 mm teeth

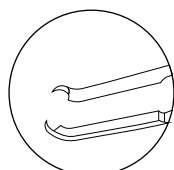

Colibri Corneal Fixation Forceps
Overall length 83 mm 1x1 pierse teeth with tying platform
PAB-464.83 0,10 mm teeth

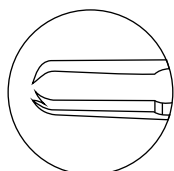

Straight Corneal Suturing Forceps

Overall length 85 mm with 1x2 teeth set at 45 dg and tying platform

PAB-465.85 0,12 mm teeth

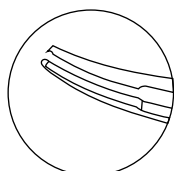

Curved Corneal Suturing Forceps

Overall length 82 mm with 1x2 teeth set at 45 dg and tying platform

PAB-466.82 0,12 mm teeth

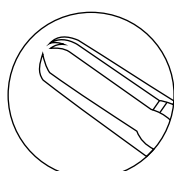

Angled Corneal Suturing Forceps

Overall length 82 mm with 1x2 teeth set at 45 dg and tying platform

PAB-467.82 0,12 mm teeth

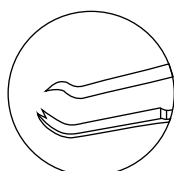

Colibri Corneal Suturing Forceps

Overall length 82 mm with 1x2 teeth set at 45 dg and tying platform

PAB-468.82 0,12 mm teeth

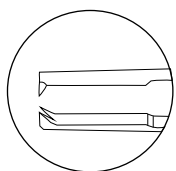

Straight Corneal Utility Forceps

Overall length 85 mm 1x2 teeth set at 90 dg with tying platform

PAB-469.85 0,12 mm teeth

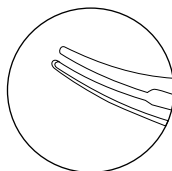

Curved Corneal Utility Forceps

Overall length 82 mm 1x2 teeth set at 90 dg with tying platform

PAB-470.82 0,12 mm teeth

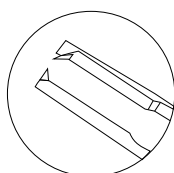

Angled Corneal Utility Forceps

Overall length 82 mm 1x2 teeth set at 90 dg with tying platform

PAB-471.82 0,12 mm teeth

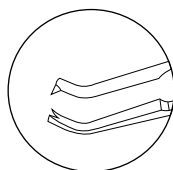

Colibri Corneal Utility Forceps

Overall length 83 mm 1x2 teeth set at 90 dg with tying platform

PAB-472.83 0,12 mm teeth

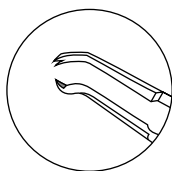

Girard Corneoscleral Forceps
Overall length 100 mm 1x2 teeth 0,12 mm with tying platform
PAB-473.01R Right handed
PAB-473.02L Left handed

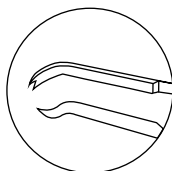

Colibri Corneoscleral Forceps
Overall length 100 mm with tying platform
PAB-474.10 1x2 teeth of 0,12 mm set at 45 dg
PAB-474.12 1x1 pierse teeth of 0,10 mm



Pierse Corneoscleral Forceps
Overall length 100 mm with tying platform and 1x1 pierse teeth 0,10 mm
PAB-475.01 Straight
PAB-475.02 Curved

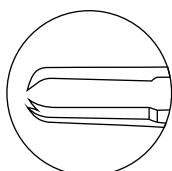

Suturing Corneoscleral Forceps
Overall length 100 mm with 1x2 teeth of 0,12 mm and tying platform
PAB-476.01 Straight
PAB-476.02 Curved

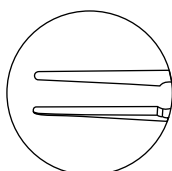

Tying Corneoscleral Forceps
Overall length 100 mm with extra fine 5 mm long tying platform for 8-0 to 11-0 sutures
PAB-477.01 Straight
PAB-477.02 Curved

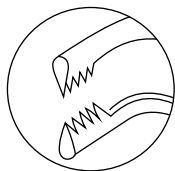

Kuhnt Capsule Forceps
Overall length 100 mm 5x5 teeth
PAB-478.10

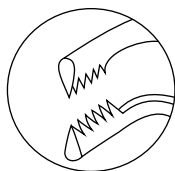

Swiss Model Capsule Forceps
Overall length 95 mm 6x6 teeth
PAB-479.95

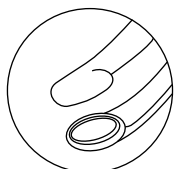

Castroviejo Capsule Forceps
Overall length 100 mm, cross action
PAB-480.10

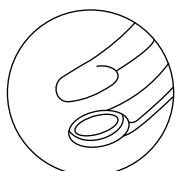

Arruga Capsule Forceps (new model)
Overall length 100 mm
PAB-481.10

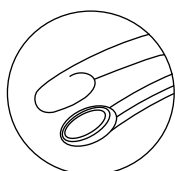

Arruga Capsule Forceps
Overall length 100 mm
PAB-482.10

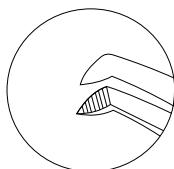

Capsulorhexis Forceps
Overall length 100 mm extremely delicate 12 mm long vaulted shanks with ultra fine serrated tips
PAB-483.10

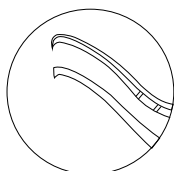

Lehner Capsulorhexis Forceps
Overall length 105 mm with delicate 11 mm long vaulted shanks and ultra fine tips
PAB-484.10

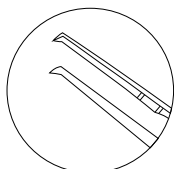

Utrata Capsulorhexis Forceps
Overall length 105 mm extra fine 11 mm long angled shanks with ultra fine tips
PAB-485.10

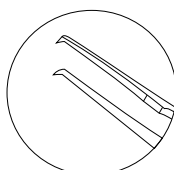

Nevyas Capsulorhexis Forceps
Overall length 105 mm with extremely thin 11 mm long cystotome shaped tips for penetrating and grasping anterior capsule
PAB-486.10

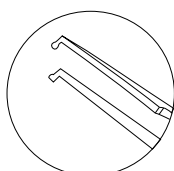

Jaffe Capsulorhexis Forceps
Overall length 105 mm with extremely thin 11 mm long shanks and extra delicate round grasping tips
PAB-487.10

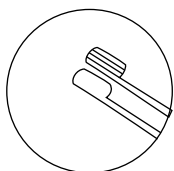

Ernest - Calf Nucleus Cracking Forceps

Overall length 105 mm extremely thin paddle shaped jaws with longitudinally serrated surfaces (cross action)
PAB-488.10

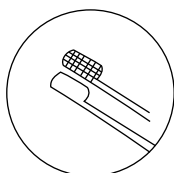

Kraff Nucleus Fracture Forceps

Overall length 105 mm extremely thin paddle shaped jaws with cross serrated surfaces (cross action)
PAB-489.10

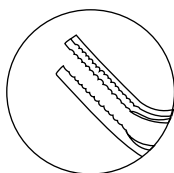

Kansas Nucleus Removal Forceps

Overall length 105 mm with angled 10 mm long delicate jaws with multiple parallel teeth
PAB-490.10

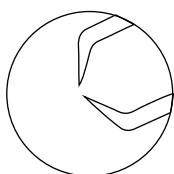

Dardenne Nucleus Fragment Forceps

Overall length 105 mm with angled 10 mm long shanks and 1 mm long grasping tips
PAB-491.10

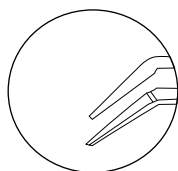

Kelman-McPherson Fragment Forceps

Overall length 100 mm with delicate angled 7.5 mm long shanks

PAB-492.10

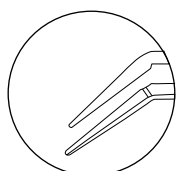

Gaskin Fragment Forceps

Overall length 105 mm with delicate 45 dg angled shanks and smooth platform

PAB-493.09 9 mm angled

PAB-493.11 11 mm angled

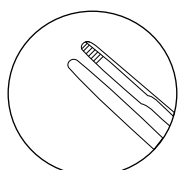

Osher Foreign Body Removal Forceps

Overall length 105 mm extra fine 11 mm long 60 dg angled shanks with 3 mm long platform

PAB-494.10

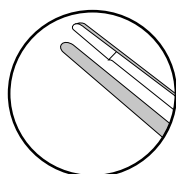

Kraff Capsule Tag Forceps

Overall length 105 mm with thin 11 mm , long shanks and 1,5 mm long platform

PAB-495.10

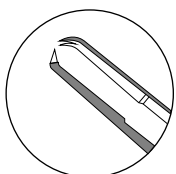

Witschel Capsule Flap Forceps

Overall length 105 mm with 45 dg angled 11 mm long shanks and 5 mm long platform with 1x2 teeth of 0,10 mm

PAB-496.10



Desmarres Chalazion Forceps

Oval blades

PAB-497.20 20 mm

PAB-497.26 26 mm

PAB-497.30 30 mm



Francis Chalazion Forceps

Overall length 95 mm oval blades 12x14 mm

PAB-498.95

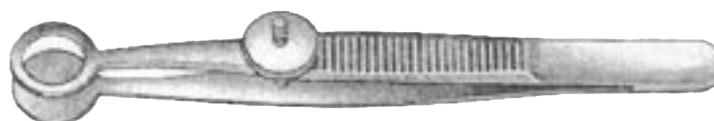

Lambert Chalazion Forceps

Overall length 90 mm round blade 8 mm dia

PAB-499.90



Hunt Chalazion Forceps

Overall length 95 mm round blade 12 mm dia

PAB-500.95



Cauer Chalazion Forceps

Overall length 100 mm round blade 12 mm serrated

PAB-501.10



Lordan Chalazion Forceps
Overall length 95 mm
PAB-502.95



Wies Chalazion Forceps
Overall length 95 mm grooved upper jaw
PAB-503.95



Berke Ptosis Forceps
Overall length 105 mm with longitudinally grooves and slide lock
PAB-504.20 20 mm
PAB-504.27 27 mm

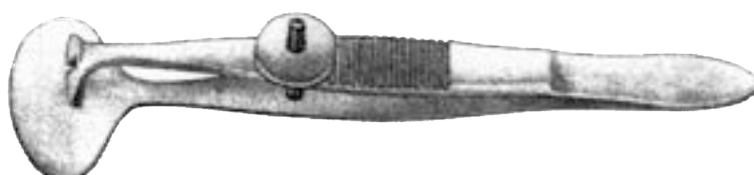

Erhardt Lid Forceps
Overall length 95 mm oval lower blade and serrated upper blade
PAB-505.95

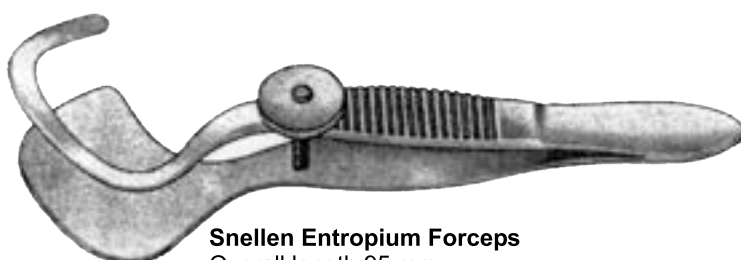

Snellen Entropium Forceps
Overall length 95 mm
PAB-506.01 Right
PAB-506.02 Left



Cueppers Strabismus Muscle Tucker
PAB-507-01



Sattler Muscle Forceps
Overall length 100 mm, angled with 3 holes and teeth
and side lock
PAB-508.22 Right
PAB-508.23 Left



Jameson Muscle Forceps (child size)
Overall length 100 mm, angled with 4 holes and teeth and
slide lock
PAB-509.01 Right
PAB-509.02 Left

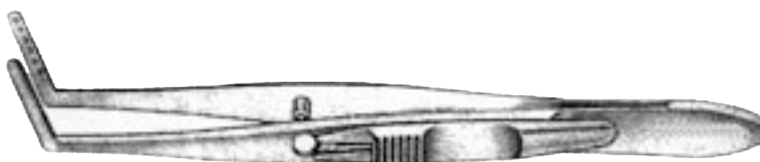

Jameson Muscle Forceps (adult size)
Overall length 100 mm, angled with 6 holes and teeth and
slide lock
PAB-510.01 Right
PAB-510.02 Left



Bangerter Muscle Forceps
Overall length 105 mm
PAB-511.10

- Eye surgery
- Augen-Instrumentarium
- Oftalmologia
- Chirurgie ophtalmologique
- Oftalmologia



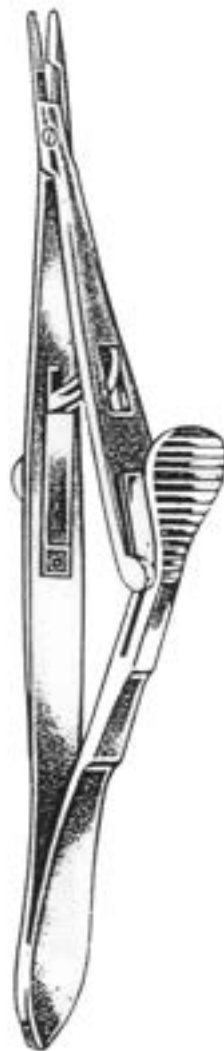
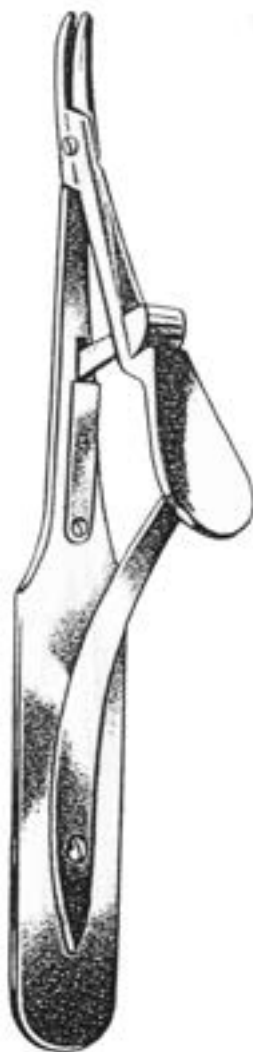
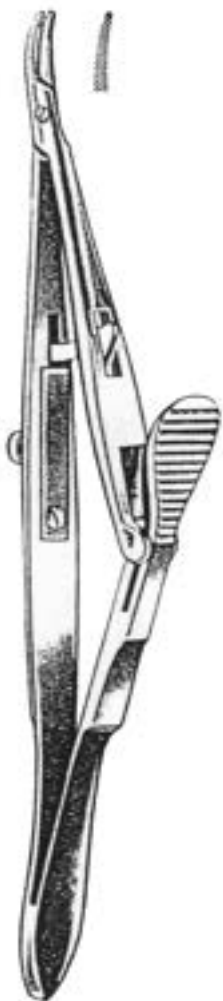

KALT

PAB-550.13
13cm
gerade
straight
recta
droit

PAB-551.13
13cm
gebogen
curved
curva
courbee

ARRUGA

PAB-552.14
14cm
gerade
straight
recta
droit

PAB-553.14
14cm
gebogen
curved
curva
courbee

CASTROVIEJO KALT

PAB-555.16 16CM

STEVENS

PAB-554.14 14cm

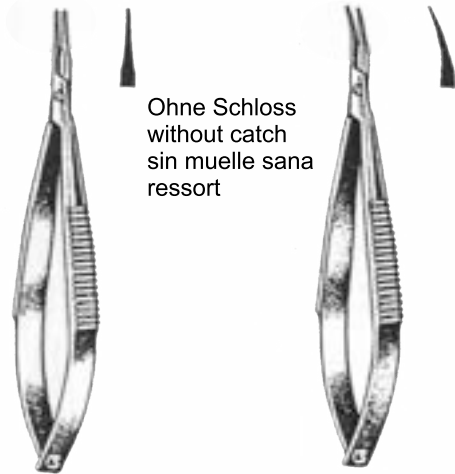

Ohne Schloss
without catch
sin muelle sana
ressort

MICRO-CASTROVIEJO
PAB-560.09 **PAB-561.09**
9cm 9cm

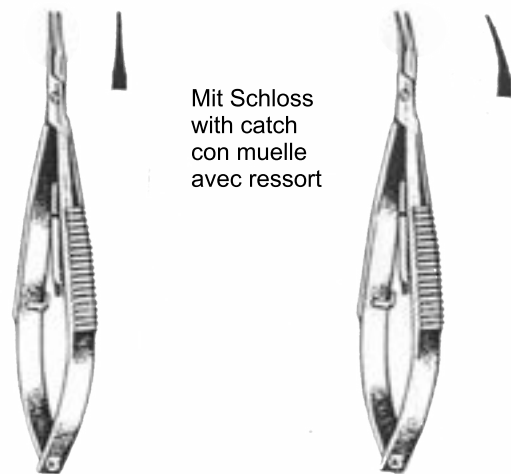

Mit Schloss
with catch
con muelle
avec ressort

MICRO-CASTROVIEJO
PAB-562.09 **PAB-563.09**
9cm 9cm

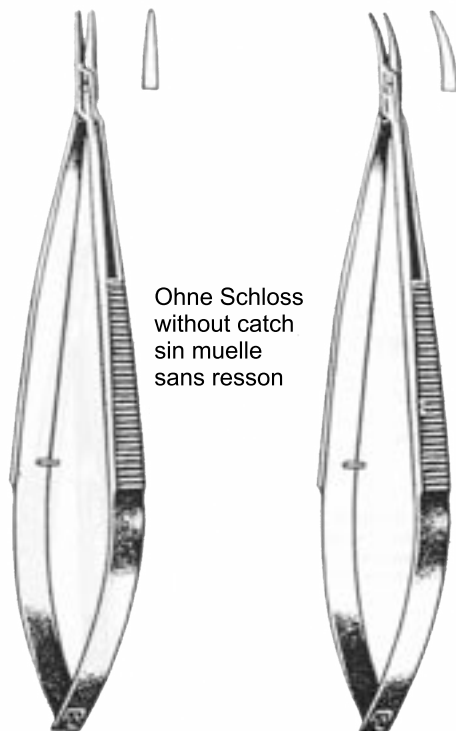

Ohne Schloss
without catch
sin muelle
sans resson

CASTROVIEJO
PAB-564.14 **CASTROVIEJO**
14 cm **PAB-565.14**
14 cm

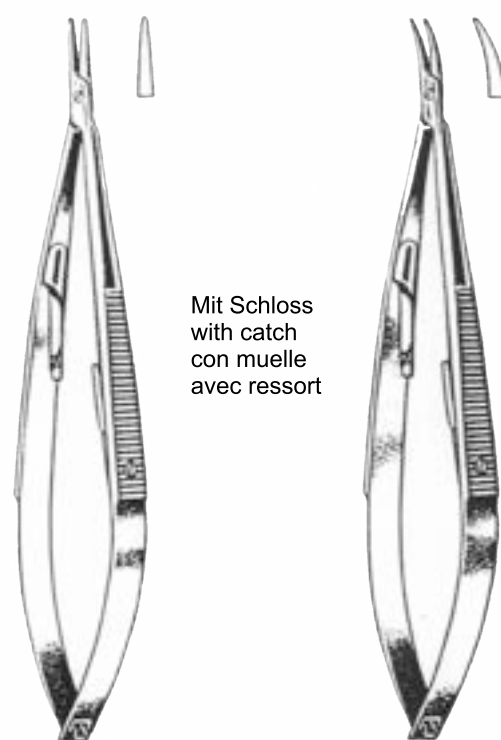

Mit Schloss
with catch
con muelle
avec ressort

CASTROVIEJO
PAB-566.14 **CASTROVIEJO**
14 cm **PAB-567.14**
14 cm

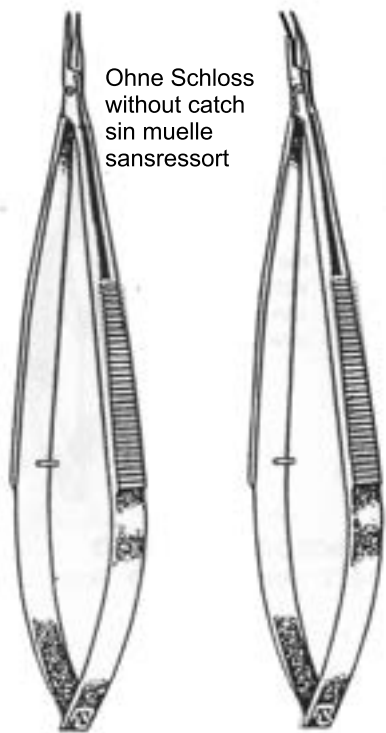

MICRO - CASTROVIEJO
PAB-570.14 14cm
PAB-571.14 14cm

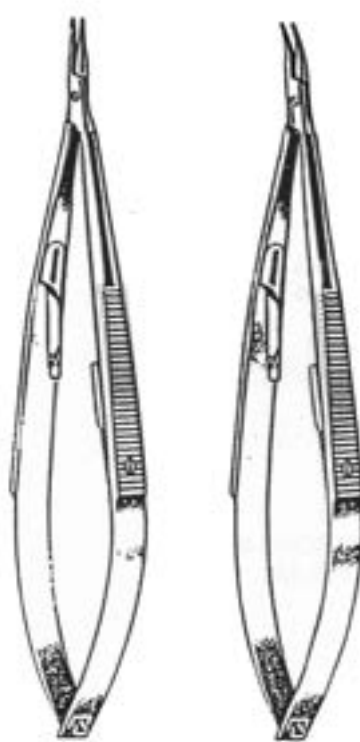

MICRO - CASTROVIEJO
PAB-572.14 14cm
PAB-573.14 14cm



CASTROVIEJO
PAB-574.14 14cm



PAB-575.10
 10 cm

Ohne Schloss
 without catch
 sin muelle
 sans ressort



BARRAQUER
PAB-576.13 13cm
PAB-577.13 13cm

Ohne Schloss
 without catch
 sin muelle
 sana ressort



BARRAQUER
PAB-578.13 13cm
PAB-579.13 13cm

Mit Schioss
 with catch
 con muelle
 avec ressort



Ohne Schloss
without catch
sin muelle
sans ressort

BARRAQUER

PAB-580.10 **PAB-581.10**
9.5 cm 9.5 cm



Mit Schloss
with catch con
muelle avec ressort

BARRAQUER

PAB-582.10 **PAB-583.10**
9.5 cm 9.5 cm



Mit Schloss
with catch
con muelle
avec ressort

PAB-584.14
13.5 cm



Mit Schloss
with catch
con muelle
avec ressort

BARRAQUER
PAB-585.13
13 cm

0.5mm



0.75mm



Ohne Schloss
without catch
sin muelle
sans ressort

BARRAQUER
PAB-587.12 PAB-588.12
11.5 cm

0.5mm



0.75mm



mit Schloss
with catch
con muelle
avec ressort

BARRAQUER
PAB-589.12 PAB-590.12
11.5 cm

0.75 mm



1.0 mm



Ohne Schloss
without catch
sin muelle
sans ressort

BARRAQUER
PAB-591.14 PAB-592.14
14 cm

0.75 mm



1.0 mm



mit Schloss
with catch
con muelle
avec ressort

BARRAQUER
PAB-593.14 PAB-594.14
14 cm

- Eye surgery
- Augen-Instrumentarium
- Oftalmologia
- Chirurgie ophtalmologique
- Oftalmologia



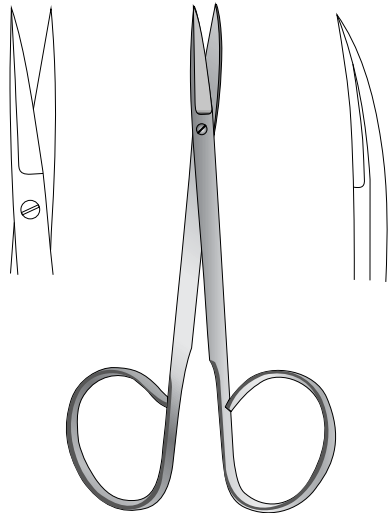

PAB-595.11 10,5 cm
Gerade
straight
recta
droit

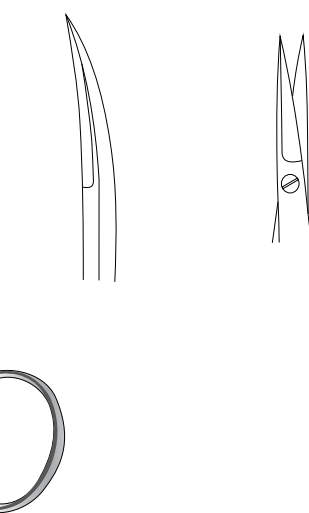

PAB-596.11
Gebogen
curved
curva
courbe

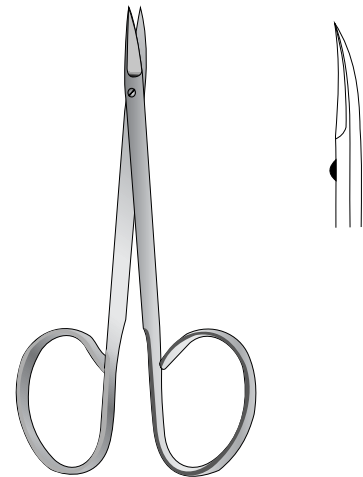

PAB-597.10 9,5 cm
Gerade
straight
recta
droit

PAB-598.10
Gebogen
curved
curva
courbe

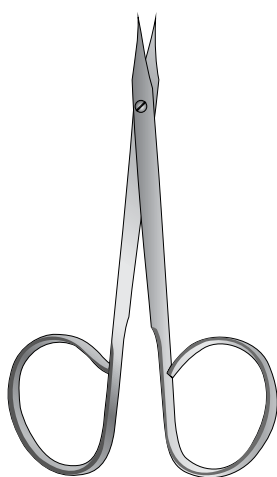

STEVENS
PAB-599.10 10 cm



STEVENS
PAB-600.10 10 cm

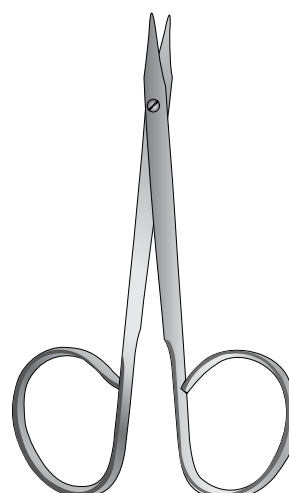

STEVENS
PAB-601.10 10 cm

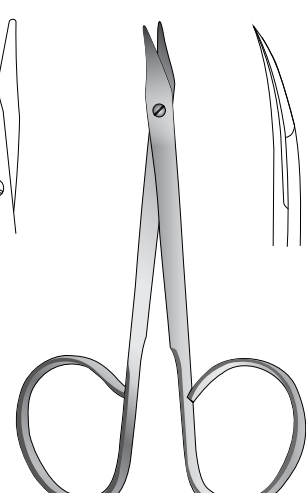

STEVENS
PAB-602.10 10 cm

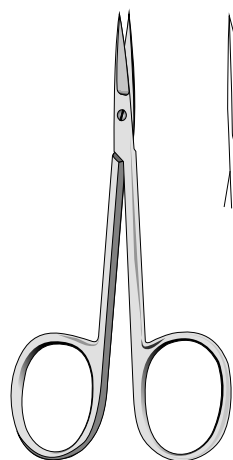

BONN
PAB-603.09
9 cm

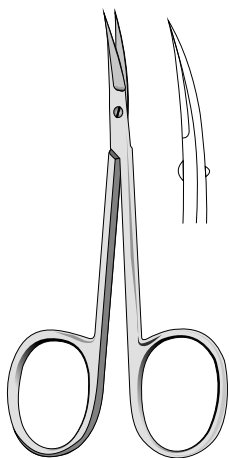

BONN
PAB-604.09
9 cm

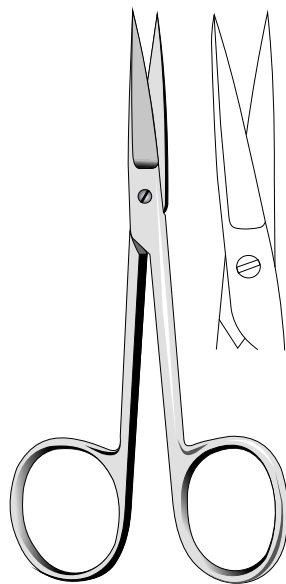

MICROSCOPIC
PAB-605.11
11 cm

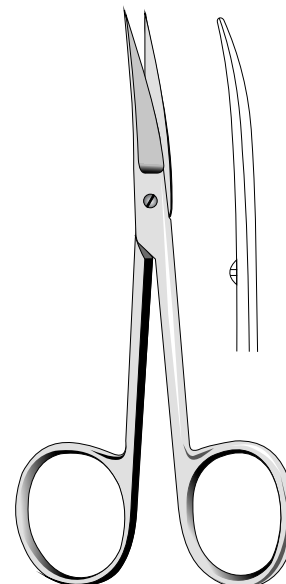

MICROSCOPIC
PAB-606.11
11 cm

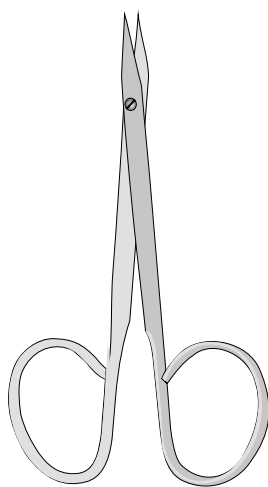

PAB-607.10
9,5 cm

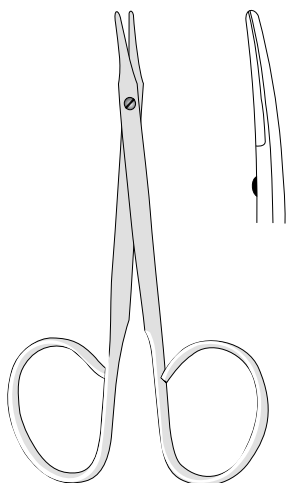

PAB-608.10
9,5 cm

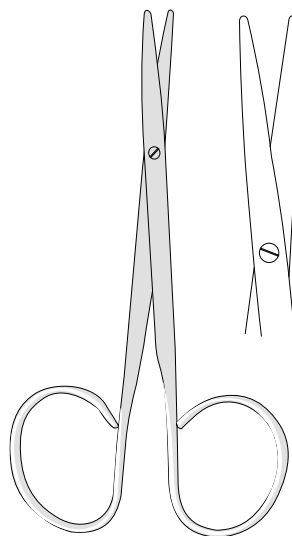

STRABISMUS
PAB-609.10
10 cm

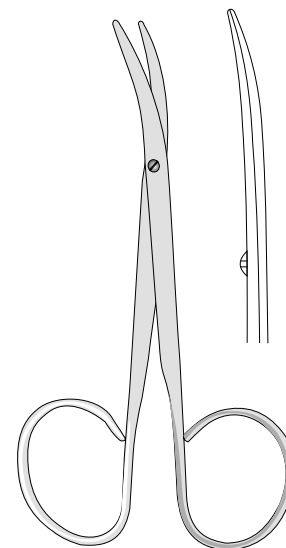

STRABISMUS
PAB-610.10
10 cm



PAB-612.09 9.0 cm
PAB-612.11 10.5cm
PAB-612.12 11.5cm

PAB-613.09 9.0 cm
PAB-613.11 10.5cm
PAB-613.12 11.5cm

PAB-614.12
 11.5 cm

PAB-615.12
 11.5 cm

PAB-616.12
 11.5 cm



KNAPP
PAB-617.11 10.5cm
PAB-617.12 12.0cm

KNAPP
PAB-618.11 10.5cm
PAB-618.12 12.0cm

KNAPP
PAB-619.11 10.5cm
PAB-619.12 12.0cm

KNAPP
PAB-620.11 10.5cm
PAB-620.12 12.0cm

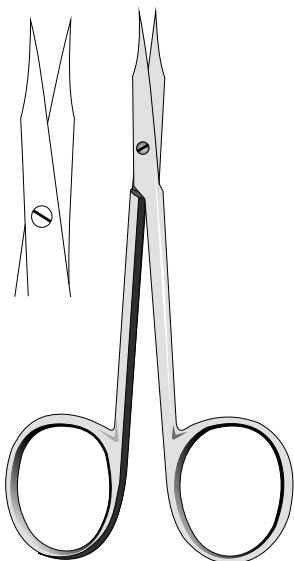

SREVENS
PAB-622.11 10,5 cm
PAB-622.12 11,5 cm

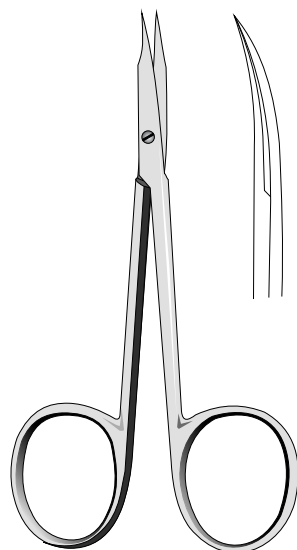

STEVENS
PAB-623.11 10,5 cm
PAB-623.12 11,5 cm



STEVENS
PAB-624.11 10,5 cm
PAB-624.12 11,5 cm

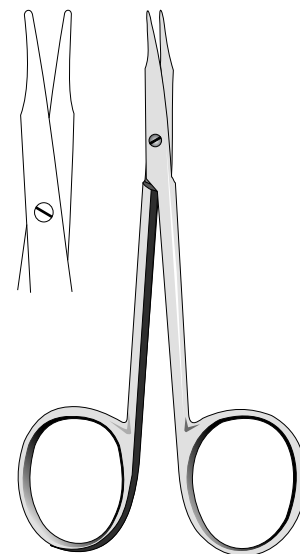

STEVENS
PAB-625.11 10,5 cm
PAB-625.12 11,5 cm



STRABISMUS
PAB-626.11
 11 cm

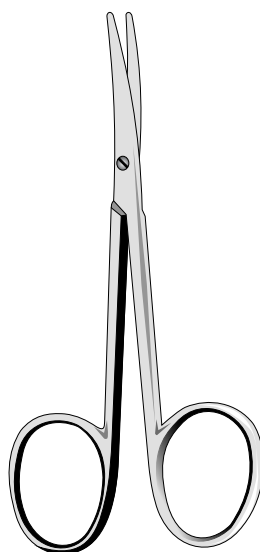

STRABISMUS
PAB-627.11
 11 cm



LAGRANGE
PAB-628.09
 9 cm

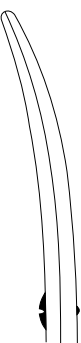
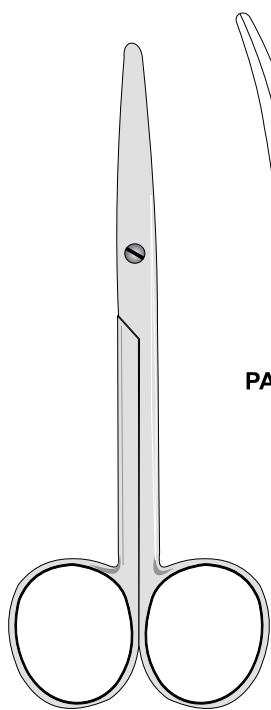

PAB-629.02

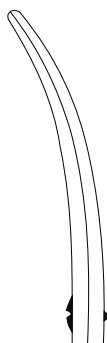

PAB-629.03

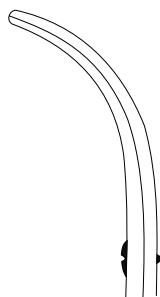

PAB-629.04



PAB-629.01 12 cm
 PAB-629.02 12 cm
 PAB-629.03 12 cm
 PAB-629.04 12 cm

PAB-630.12 11,5 cm
 Fur Kinder
 for children
 para ninos
 pour enfants

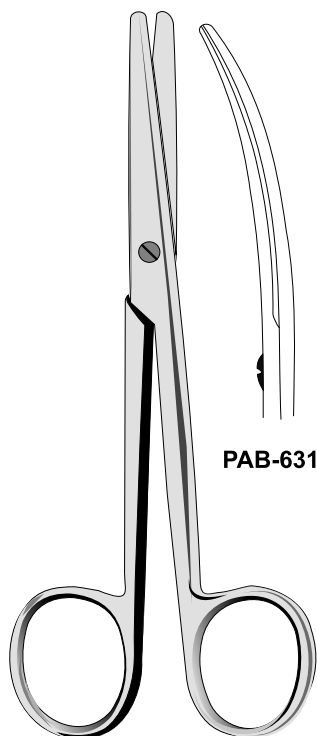

PAB-631.01

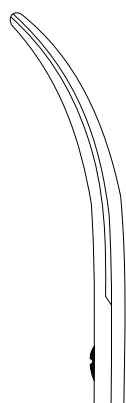

PAB-631.02

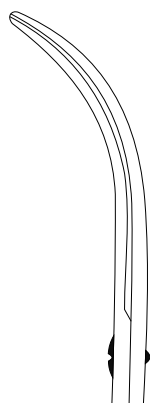

PAB-631.03

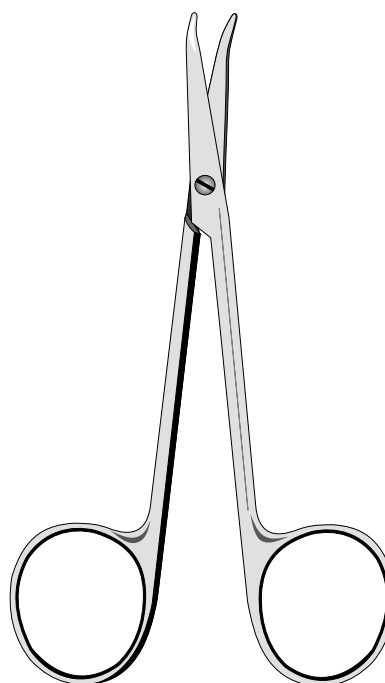

PAB-631.01 13,5 cm
 PAB-631.02 13,5 cm
 PAB-631.03 13,5 cm

WERBS DCR SCISSORS
 11 cm, 30 mm blades,
 with 5mm angled ends



PAB-635.02



PAB-636.02



PAB-637.02



PAB-638.02



PAB-639.02



PAB-640.02



PAB-635.03



PAB-636.03



PAB-637.03



PAB-638.03



PAB-639.03



PAB-640.03



PAB-635.04



PAB-636.04



PAB-637.04



PAB-638.04



PAB-639.04



PAB-640.04



PAB-635.02 10cm
PAB-635.03 10cm
PAB-635.04 10cm

PAB-636.02 10cm
PAB-636.03 10cm
PAB-636.04 10cm

PAB-637.02 11cm
PAB-637.03 11cm
PAB-637.04 11cm

PAB-638.02 11cm
PAB-638.03 11cm
PAB-638.04 11cm

NOYES
PAB-639.02 11.5cm
PAB-639.03 11.5cm
PAB-639.04 11.5cm

NOYES
PAB-640.02 11.5cm
PAB-640.03 11.5cm
PAB-640.04 11.5cm



**TUEBINGEN
PAB-642.85**
8.5 cm



**TUEBINGEN
PAB-643.85**
8.5 cm



PAB-644.80 8.5 cm



PAB-645.80 8.5 cm

Trabekular-Schere
Trabekular scissors
Tijeras trabeculares
Ciseaux a trabeculaires

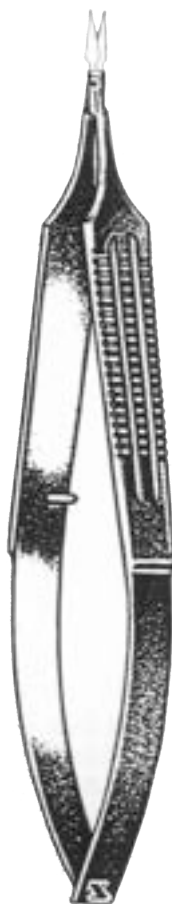

**CASTROVIEJO -
VANNAS
PAB-646.12**
11.5 cm

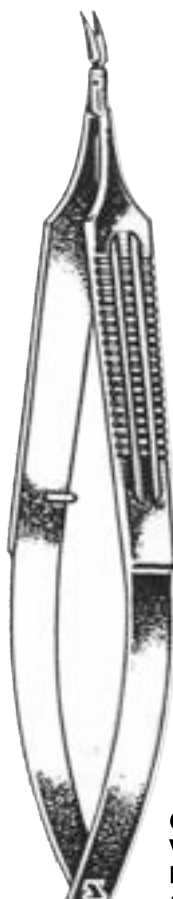

**CASTROVIEJO -
VANNAS
PAB-647.12**
11.5 cm

Sharp pointed tips.
11 mm from mid screw
to tip



**McPHERSON-VANNAS
PAB-648.85**
8,5 cm



VANNAS
PAB-649.80
8 cm



VANNAS
PAB-650.80
8 cm



VANNAS
PAB-651.80 8 cm
PAB-652.80 8 cm



VANNAS
PAB-652.80
8 cm

Extra klein - extremely delicate - delicate - extra fine



VANNAS
PAB-653.80
8 cm



VANNAS
PAB-654.80
8 cm



VANNAS
PAB-655.80
8 cm



VANNAS
PAB-656.80
8 cm

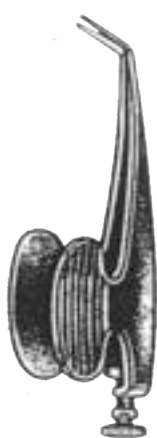
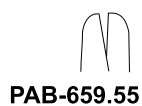
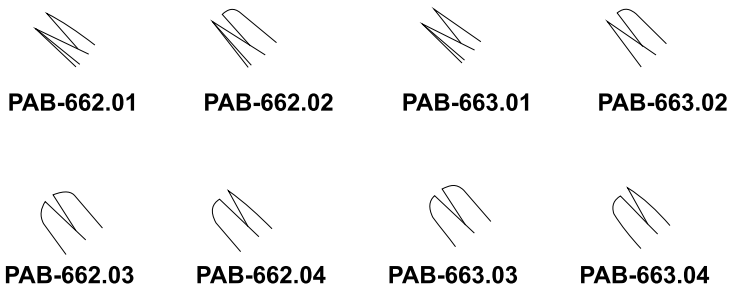

BARRAQUER
PAB-658.55 5.5 cm
PAB-659.55 5.5 cm

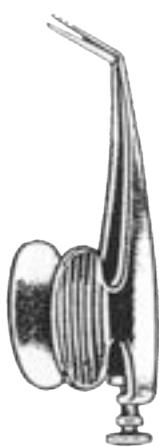

BARRAQUER
PAB-660.55 5.5 cm
PAB-661.55 5.5 cm

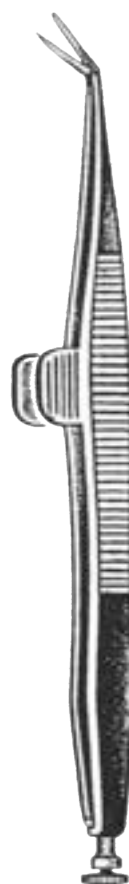

WECKER
PAB-662.01 11.5cm
PAB-662.02 11.5cm
PAB-662.03 11.5cm
PAB-662.04 11.5cm

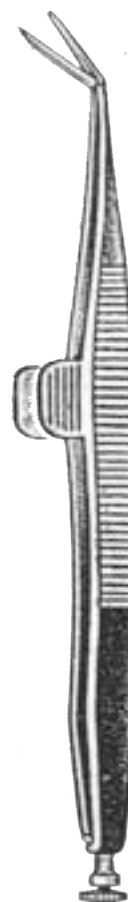

WECKER
PAB-663.01 11.5cm
PAB-663.02 11.5cm
PAB-663.03 11.5cm
PAB-663.04 11.5cm

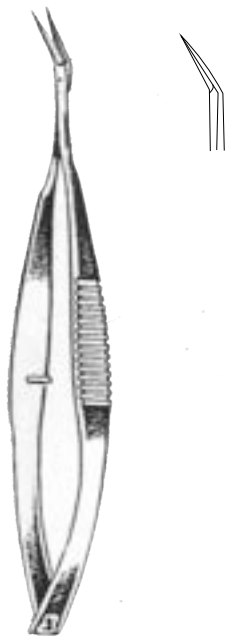

GIL
PAB-664.01

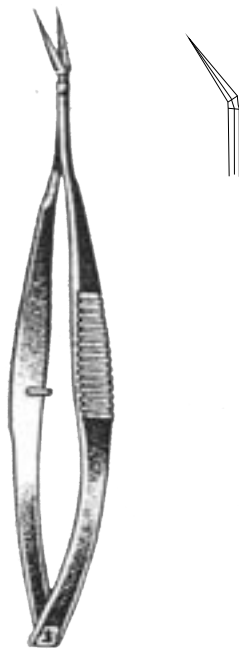

ONG
PAB-665.02

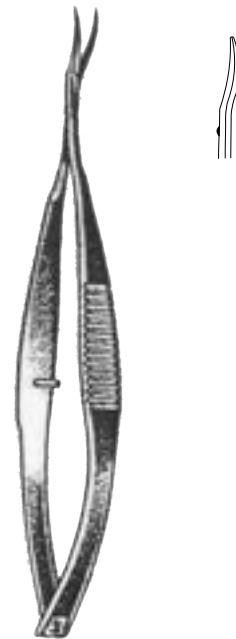

UTHOFF
PAB-666.03

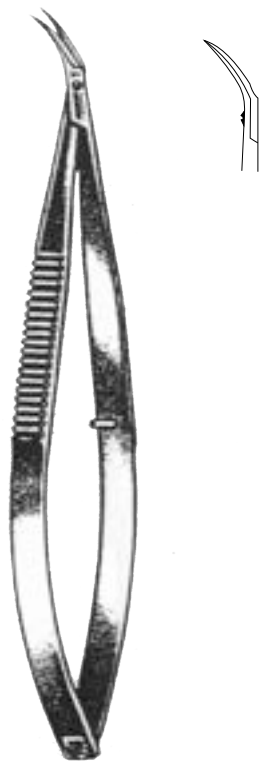

URIBE-STERN
PAB-667.04

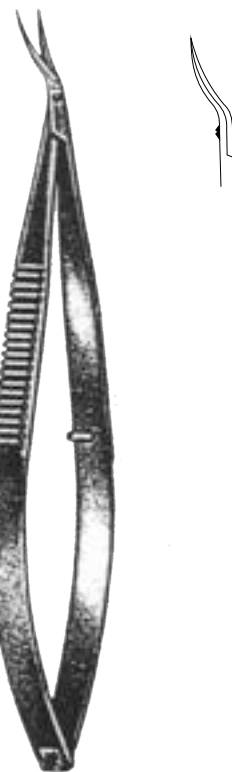

HOFFER-STERN
PAB-668.05



PAB-670.10
10cm

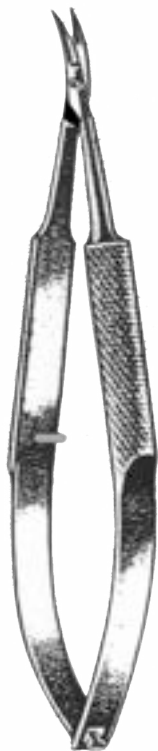

PAB-671.10
10cm



PAB-672.10
10cm



PAB-673.10
10cm

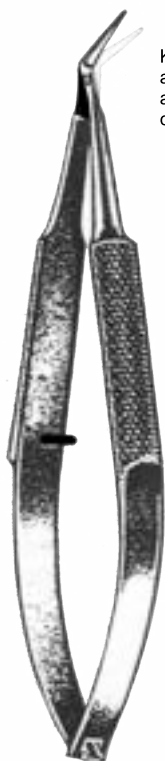

PAB-674.10
10cm

Kniegebogen
angled to side
anguloso
coude



PAB-675.10
10cm



PAB-676.10
10cm

Aufgewinkelt
angled on flat
anguloso
angulaire



PAB-677.10
10cm

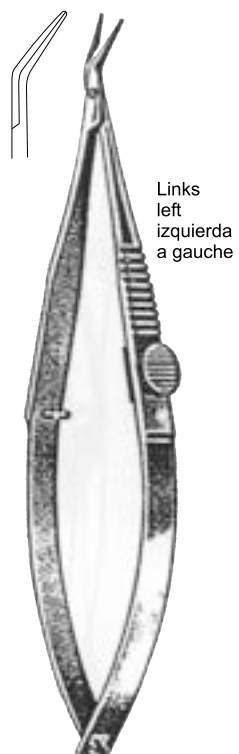

**BARRAQUER
PAB-678.01**

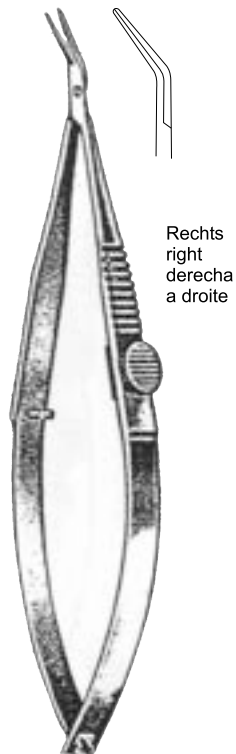

**BARRAQUER
PAB-679.01**

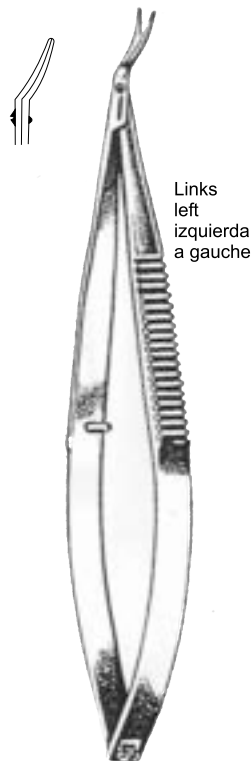

**MC QUIRE
PAB-680.01**

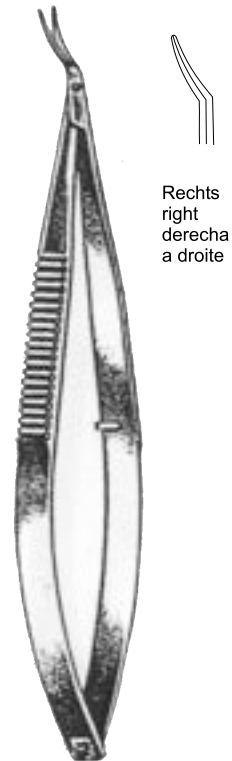

**MC QUIRE
PAB-681.01**

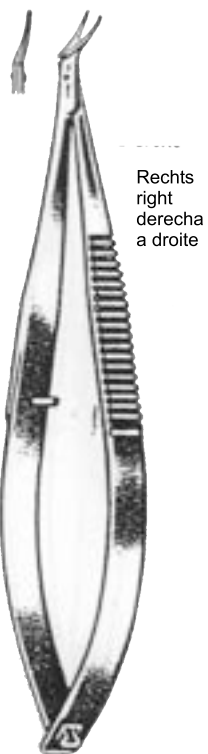

**TROUTMAN-
CASTROVIEJO
PAB-682.01**

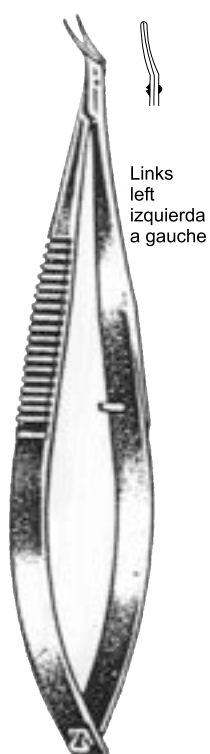

**TROUTMAN-
CASTROVIEJO
PAB-683.01**

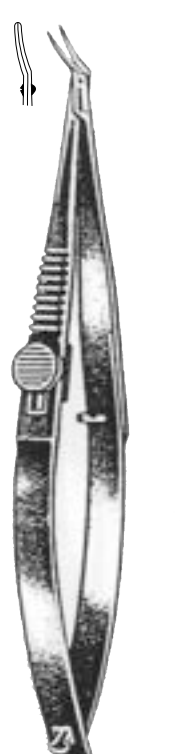

**TROUTMAN
PAB-684.01**

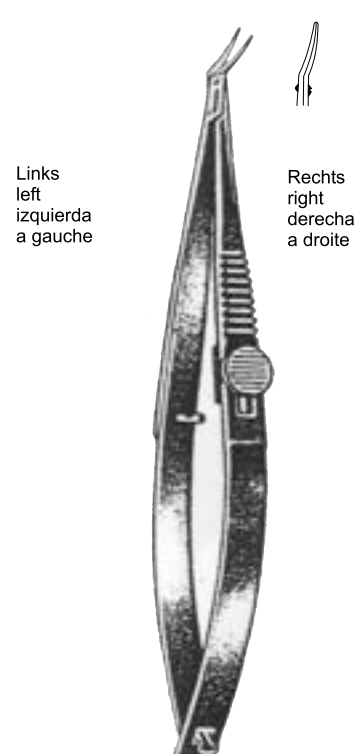

**TROUTMAN
PAB-685.01**

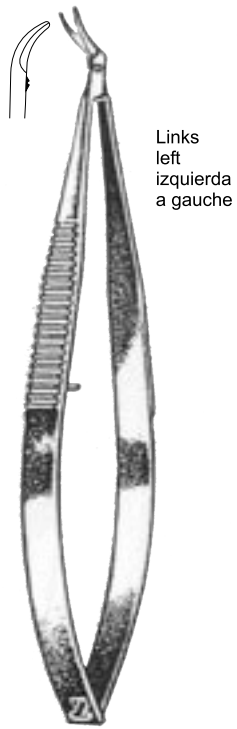

**KATZIN
PAB-686.01**

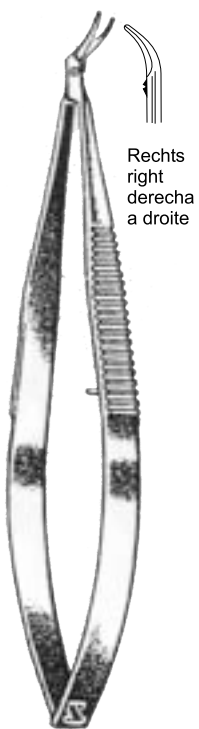

**KATZIN
PAB-687.01**

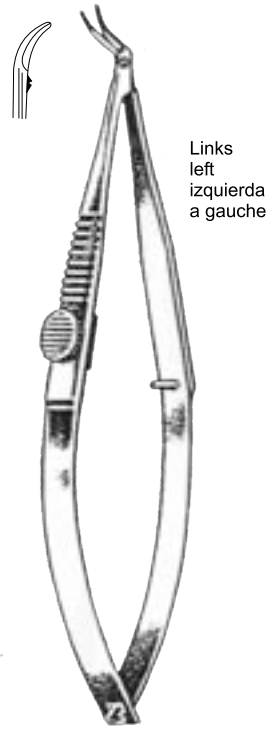

**KATZIN
PAB-688.01**

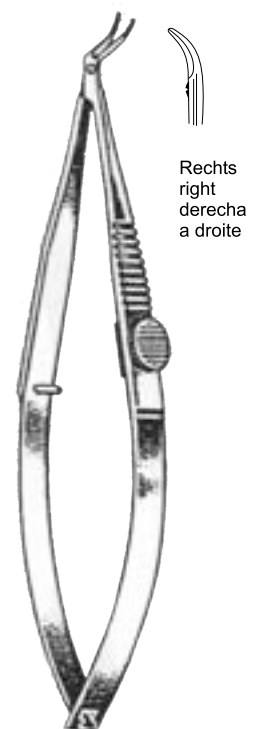

**KATZIN
PAB-688.01**

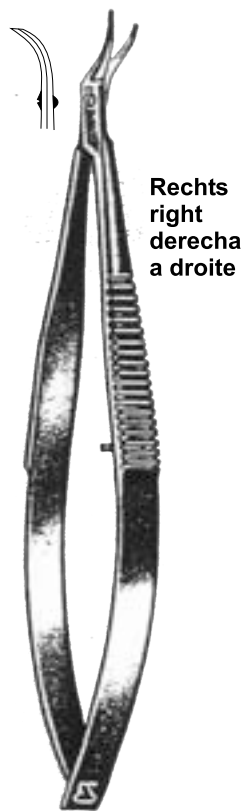

**KATZIN
PAB-689.01**

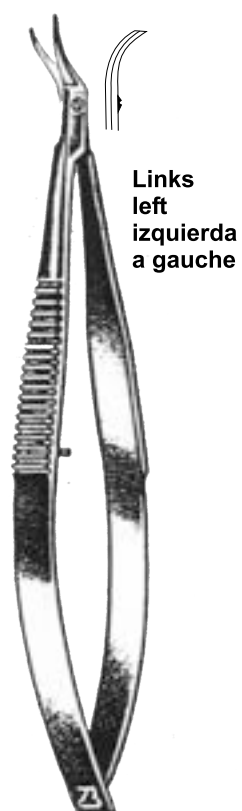

**KATZIN
PAB-690.01**

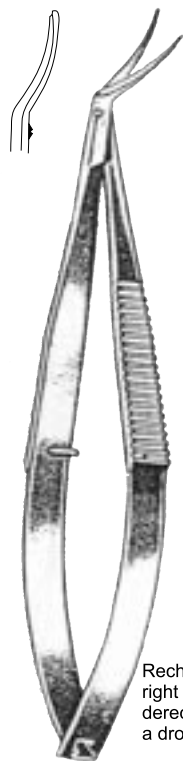

Rechts
right
derecha
a droite

**CASTROVIEJO
PAB-691.10**
10cm

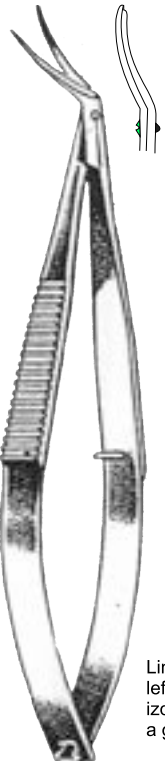

Links
left
izquierda
a gauche

**CASTROVIEJO
PAB-692.10**
10cm



Rechts
right
derecha
a droite

**MINI-CASTROVIEJO
PAB-693.10**
10cm



Links
left
izquierda
a gauche

**MINI-CASTROVIEJO
PAB-694.10**
10cm

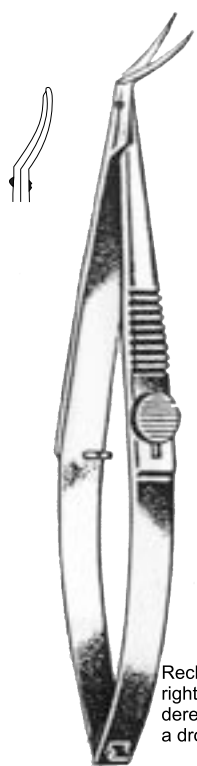

Rechts
right
derecha
a droite

**MINI-CASTROVIEJO
PAB-695.10**
10cm

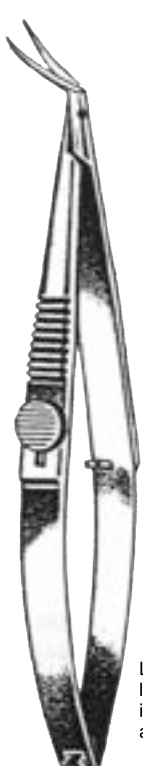

Links
left
izquierda
a gauche

**MINI-CASTROVIEJO
PAB-696.10**
10cm

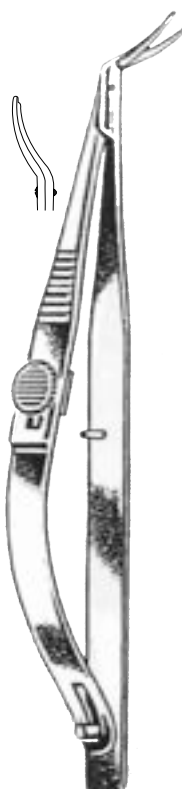

**MINI-CASTROVIEJO
PAB-697.11**
10.5cm

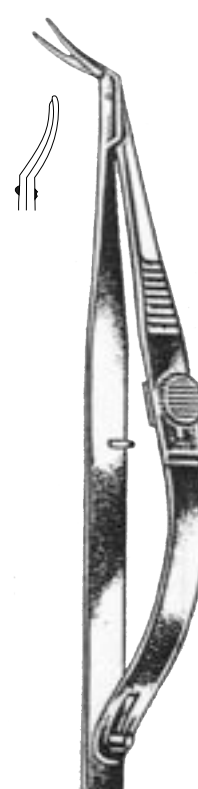

**MINI-CASTROVIEJO
PAB-698.11**
10.5cm



Rechts
right
derecha
a droite

**MICRO-CASTROVIEJO
PAB-699.10**
10cm



Links
left
izquierda
a gauche

**MICRO-CASTROVIEJO
PAB-700.10**
10cm

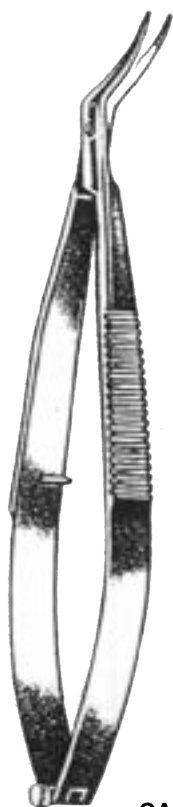

**CASTROVIEJO
PAB-701.11**
10.5cm



Rechts
right
derecha
a droite

**MINI-CASTROVIEJO
PAB-702.13**
12.5cm

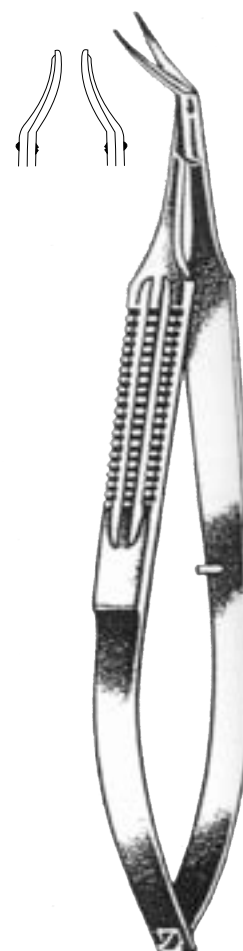

Links
left
izquierda
a gauche

**MINI-CASTROVIEJO
PAB-703.13**
12.5cm

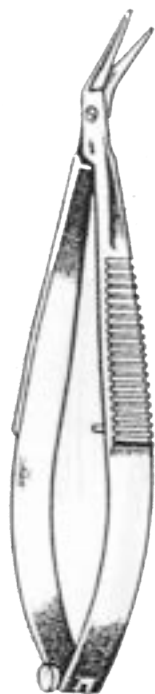

CASTROVIEJO
PAB-704.90
9 cm



CASTROVIEJO
PAB-705.90
9 cm





PAB-706.90

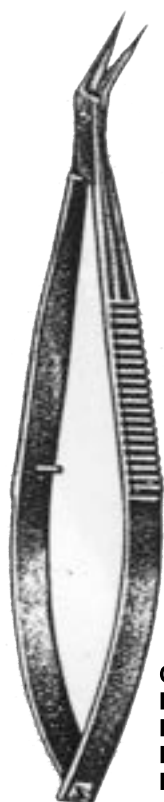

PAB-707.90

CASTROVIEJO
PAB-706.90 9 cm
PAB-707.90 9 cm



CASTROVIEJO
PAB-708.01 10.5cm
PAB-708.02 10.5cm
PAB-708.03 10.5cm
PAB-708.04 10.5cm



PAB-708.01



PAB-708.02



PAB-708.03



PAB-708.04



WESTCOTT
PAB-709.11
11cm



WESTCOTT
PAB-710.11 11cm
PAB-710.13 13cm



WESTCOTT
PAB-711.11
11cm

- Eye surgery
- Augen-Instrumentarium
- Oftalmologia
- Chirurgie ophtalmologique
- Oftalmologia

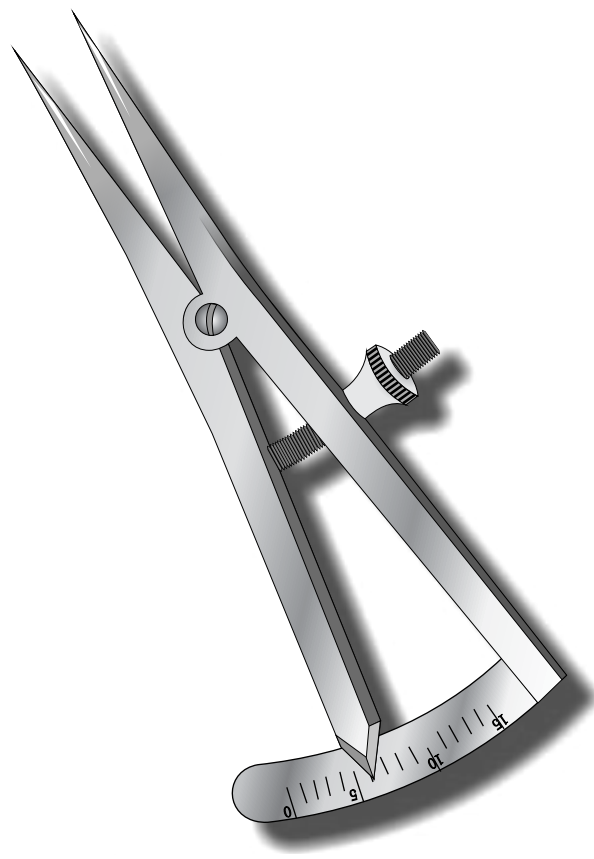

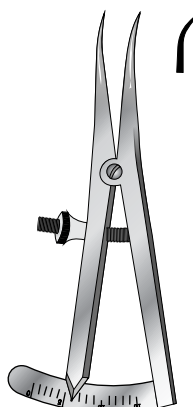
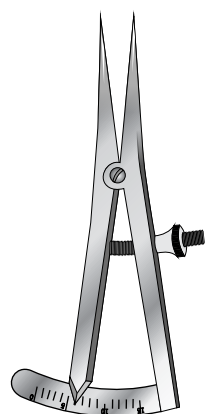

CASTROVIEJO-SCHAECHER
PAB-721.70 7 cm



PAB-722.11



WILDER
PAB-723.11
11 cm, 4 1/2"



PAB-724.11

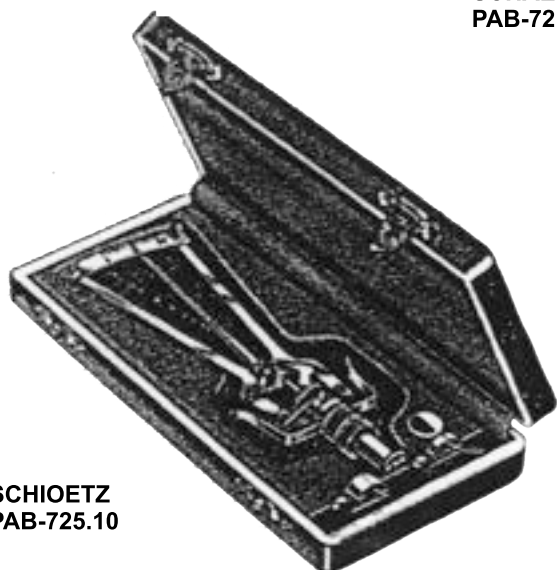

SCHIOETZ
PAB-725.10

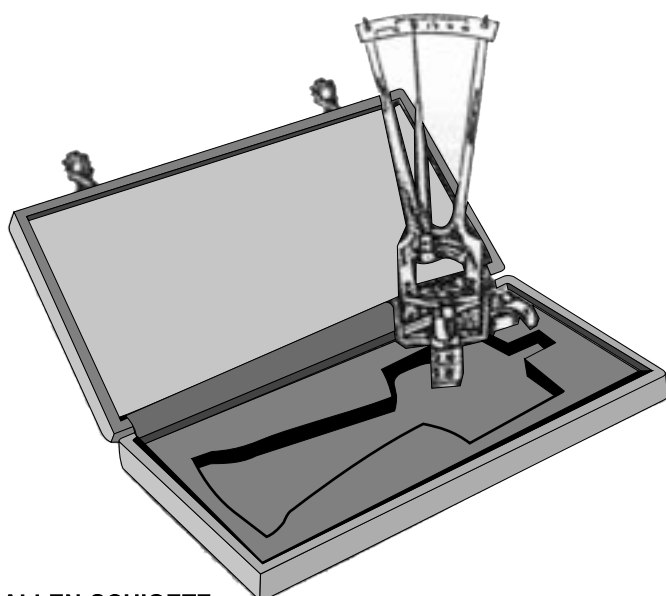

ALLEN-SCHIOETZ
PAB-726.11



CASTROVIEJO
PAB-727.12
12CM, 4 3/4"



ZIEGLER
PAB-728.12 1 + 2
PAB-728.34 3 + 4
PAB-728.56 5 + 6
14cm



BOWMAN

- PAB-730.04 Fig. 0000/000
- PAB-730.03 Fig. 000/00
- PAB-730.02 Fig. 00/0
- PAB-730.11 Fig. 0/1
- PAB-730.12 Fig. 1/2
- PAB-730.23 Fig. 2/3
- PAB-730.34 Fig. 3/4
- PAB-730.45 Fig. 4/5
- PAB-730.56 Fig. 5/6
- PAB-730.67 Fig. 6/7
- PAB-730.78 Fig. 7/8

Neusilber
German Silver
Metal blanco
Ruolz

BOWMAN

- PAB-731.04 Fig. 0000/000
- PAB-731.03 Fig. 000/00
- PAB-731.02 Fig. 00/0
- PAB-731.01 Fig. 0/1
- PAB-731.12 Fig. 1/2
- PAB-731.23 Fig. 2/3
- PAB-731.34 Fig. 3/4
- PAB-731.45 Fig. 4/5
- PAB-731.56 Fig. 5/6
- PAB-731.67 Fig. 6/7
- PAB-731.78 Fig. 7/8

Silber 800
Steriling silver
plata argent



- 4/0 3/0 = 0,6 / 7,0 mm
- 3/0 2/0 = 0,7 / 0,8 mm
- 2/0 0 = 0,8 / 0,9 mm
- 0 / 1 = 0,9 / 1,0 mm
- 1 / 2 = 1,0 / 1,2 mm
- 2 / 3 = 1,2 / 1,3 mm
- 3 / 4 = 1,3 / 1,4 mm
- 4 / 5 = 1,4 / 1,5 mm
- 5 / 6 = 1,5 / 1,6 mm
- 6 / 7 = 1,6 / 1,8 mm
- 7 / 8 = 1,8 / 2,0 mm



BOWMAN

- PAB-732.04 Fig. 0000/000
- PAB-732.03 Fig. 000/00
- PAB-732.02 Fig. 00/0
- PAB-732.01 Fig. 0/1
- PAB-732.12 Fig. 1/2
- PAB-732.23 Fig. 2/3
- PAB-732.34 Fig. 3/4
- PAB-732.45 Fig. 4/5
- PAB-732.56 Fig. 5/6
- PAB-732.67 Fig. 6/7
- PAB-732.78 Fig. 7/8

Neusilber
German Silver
Metal blanco
Ruolz

BOWMAN

- PAB-733.04 Fig. 0000/000
- PAB-733.03 Fig. 000/00
- PAB-733.02 Fig. 00/0
- PAB-733.01 Fig. 0/1
- PAB-733.12 Fig. 1/2
- PAB-733.23 Fig. 2/3
- PAB-733.34 Fig. 3/4
- PAB-733.45 Fig. 4/5
- PAB-733.56 Fig. 5/6
- PAB-733.67 Fig. 6/7
- PAB-733.78 Fig. 7/8

Silber 800
Steriling silver
plata argent





West Lacrimal Chisel
PAB-734.16
 Straight 16cm



West Lacrimal Gouge
PAB-735.16
 16cm



Freer Periosteal Elevator
PAB-736.18
 18cm D/E sharp/blunt 4,5 mm wide



Joseph Periosteal Elevator
PAB-737.16
 16 cm 4 mm wide

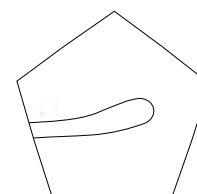
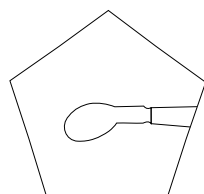

Tenzel D/E Periosteal Elevator
PAB-738.19
 195 mm shaft marked at 10mm, 20mm,
 and 30mm from tip of dissector end



Luftkanule
Air injection cannula
Cannula para aire
Canule a air

PAB-750.04 27G., 0.4MM
PAB-750.06 23G., 0.6MM



Luftkanule
Air injection cannula
Cannula para aire
Canule a air

PAB-751.04 27g., 0.4MM
PAB-751.06 23g., 0.6MM



PAB-752.04 27G., 0.4MM
PAB-752.06 23G., 0.6MM



Luftkanule
Air injection cannula
Cannula para aire
Canule a air

PAB-753.27 27g
PAB-753.30 30g



Healon injektionskanule
Healon injection cannula
Canula para inyeccion de healon
Canule pour injection d' healon

PAB-754.01



ANEL
PAB-755.01

Traenenwegkanule
Lacrimal cannula
Canula para canal lacrimal
Canule a voie lacrymal



ANEL
PAB-756.01

Traenenwegkanule
Lacrimal cannula
Canula para canal lacrimal
Canule a voie lacrymal



PAB-757.01

Traenenwegkanule
Lacrimal cannula
Canula para canal lacrimal
Canule a voie lacrymal



PAB-758.01

• Chirurgie ophtalmologique • Oftalmologia

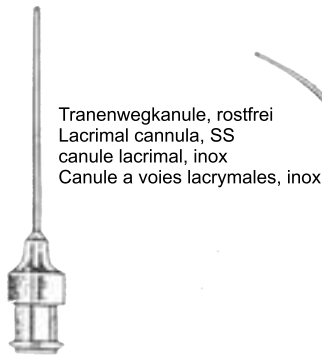

PAB-760.01

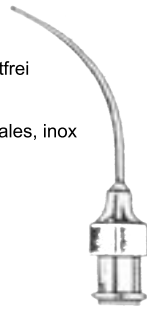

PAB-761.01



PAB-762.01



PAB-763.01

Tränenwegkanule, rostfrei
 Lacrimal cannula, SS
 canule lacrimale, inox
 Canule a voies lacrymales, inox

Tränenwegkanule mit 2 seitlichen Öffnungen
 Lacrimal cannula with 2 lateral holes
 Canula lacrimale con 2 orificios laterales
 Canule a voies lacrymales avec 2 orifices laterales



**MC INTYRE
 PAB-764.40**



**MC INTYRE
 PAB-765.21**

Retrobulbare Kanüle, 40x0.6mm
 Retrobulbar needle, 40mm x 23g
 Canule retrobulbar 40x0.6mm
 Canule retrobulbaire, 40x0.6mm

Alpha - Chymotrypsin Kanüle
 Alpha - Chymotrypsin cannula
 Alpha - Chymotrypsin canula
 Alpha - Chymotrypsin canule



**ATKINSON
 PAB-766.40**



**TROUTMAN
 PAB-767.01**

Kanüle zur Cyclodialyse
 Cyclodialysis cannula
 Canula para ciclodialis
 Canule pour cyclodialyse

Kanüle zur Cyclodialyse
 Cyclodialysis cannula
 Canula para ciclodialis
 Canule pour cyclodialyse

Kanüle zur Cyclodialyse
 Cyclodialysis cannula
 Canula para ciclodialis
 Canule pour cyclodialyse



PAB-768.10

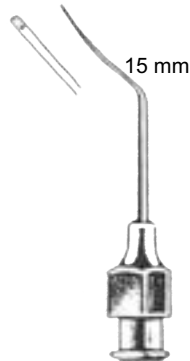

PAB-769.15



PAB-770.11

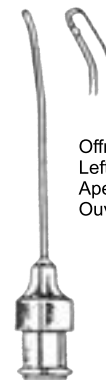

PAB-771.12



PAB-772.31

Offnung rechts
 Right side opening
 Apertura a la derecha
 Ouverture a droite

Offnung links
 Left side opening
 Apertura a la izquierda
 Ouverture a gauche

• Eye surgery • Augen-Instrumentarium • Oftalmologia

Spulkanule fur radiale keratotomie
Radial Keratotomy irrigating cannula
Canula para irrigacion para queratotomia radial
Canule irrigatoire poue la keratotomie radiale



SHEPARD
PAB-773.01

Spulkanule, seitliche offnung
irrigating cannula, lateral opening
Canula para irrigacion, orofocio lateral
Canule irrigatoire, orifice lateral



WEST
PAB-774.20 20 g
PAB-774.23 23 g

Sondenkanule
Probe cannula
Canula tipo sonda
Canule - sonde



BANGERTER
PAB-775.46 40 X 0.6mm
PAB-775.48 40 X 0.8mm
PAB-775.66 60 x 0.6mm
PAB-775.68 60 x 0.8mm

Augenbrause
Irrigating anterior chamber cannula
Canula para irrigacion de camara anterior
Canule irrigatoire multitrans



CRANZ
PAB-776.90

Kortex - Extractor
Cortex Extractor
Extractor para corteza
Extracteur de cortex



MC INTYRE
PAB-777.10 **PAB-778.11**
Gerade Gewinkelt
straight angled
recto anguloso
droit coudee



MC INTYRE
PAB-779.23 23 g
PAB-779.26 26 g
PAB-779.30 30 g



MC INTYRE
PAB-780.23 23 g
PAB-780.26 26 g
PAB-780.30 30 g



KNOLLE
PAB-781.23 23 g
PAB-781.30 30 g



SIMCO
PAB-782.13 13 mm
PAB-782.21 21mm

Spulkanule mit Irishakchen
Irrigating iris hook
Cancho oros de irrigacion
irrigateur avec crochet pour l'iris



MC INTYRE
PAB-783.20 **PAB-783.21**
Gerade Gewinkelt
straight angled
recto anguloso
droit coudee

Kapselpolierer, diamantbeschichtet
 Capsule polisher, diamond dusted
 Pulidor para capsula, con diamante
 Polisher capsulaire, diamante

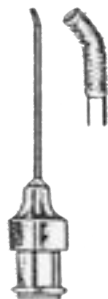

KRATZ
PAB-785.01

Kapselpolierer, diamantbeschichtet
 Posterior capsule polisher, diamond dusted
 Pulidor para capsula, con diamante
 Polisher capsulaire, diamante



RUBMAN - KATZIN
PAB-786.01



JENSEN
PAB-787.21
PAB-787.25

Kapselpolierer, diamantbeschichtet
 Posterior capsule polisher, diamond dusted
 Pulidor para capsula, con diamante
 polissoir capsulaire, diamante



KNOLLE
PAB-788.23 23 g
PAB-788.30 30 g



KNOLLE
PAB-789.23 23 g
PAB-789.30 30 g



Saugkeile
 Absorbing points
 Cunas absorbentes
 coins absorbents

Packung 10 Stuck, steril
 Package of 10 ea., Sterile
 Paquete de 10 piezas, esteril
 Boîte a 10 pieces, sterile

PAB-790.00

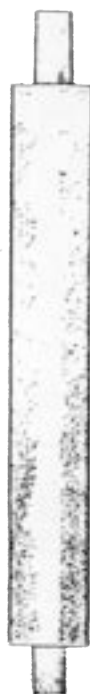

Handriff
 Infusion handle
 Mango para infusion
 Manche pour perfusion

MC INTYRE
PAB-791.60



Handriff
 Infusion handle
 Mango para infusion
 Manche pour perfusion

KANSAS
PAB-792.70



Holth Corneoscleral Punch

Overall length 87mm

PAB-795.10 1,0 mm wide

PAB-790.15 1,5 mm wide

PAB-797.20 2,0 mm wide

CONTACT US:



T.I.G International
3/199 Street No.1,
Puran Nagar Paris Road,
Sialkot-51310, Pakistan.

Tel: +92-300-6166818
Fax: +92-52-3559212
WhatsApp: +92-300-6166818
Email: info@tig-int.net / tigint786@hotmail.com
URL: www.tig-int.net



Mark Approved

